

Cables, Amplifiers and Speaker interactions. part 1.

Final version.

Cyril Bateman investigates a cause of audible distortion and amplifier failures. In confidence, not yet published.

Many people claim to hear audible differences with change of speaker cable, so having five quite different cables to hand, covering a range of self capacitance, inductance and RF impedance, I decided to see whether any measurable change in distortion did occur when changing cable types while driving into a representative loudspeaker load. I have two quite different distortion meters, one which measures conventional 1kHz second and third harmonic distortion, down to 1ppm or -120dB, see reference 1, the other, intermodulation distortion as a 4kHz amplitude, using test frequencies of 8kHz and 11.95kHz, the TDFD or Total Difference-Frequency Distortion method proposed by A. N. Thiele in 1975.

For test amplifiers, I had pairs of the D. Self “Blameless” bi-polar 50 watt class B amplifier and the popular Maplin 50 watt Hitachi lateral mosfet designs. My usual listening system comprises an Acoustic Research 40 watt bi-polar amplifier driving a pair of two way horn loaded cabinets with crossover around 250Hz, via very low resistance 100Ω RF impedance cables. To minimise man-handling of these weighty cabinets into my workroom, I assembled a “replica” of the published ESP two way crossover, using a Kef T27 tweeter and bass driver. This ESP schematic was chosen because it had previously been simulated using Spice standard L, C, R components and the results published on web sites. I wanted to clarify the true behaviour of my cables with this crossover network using measurements of an actual assembly, to compare with values also measured using my horn loaded speakers. Fig 1.

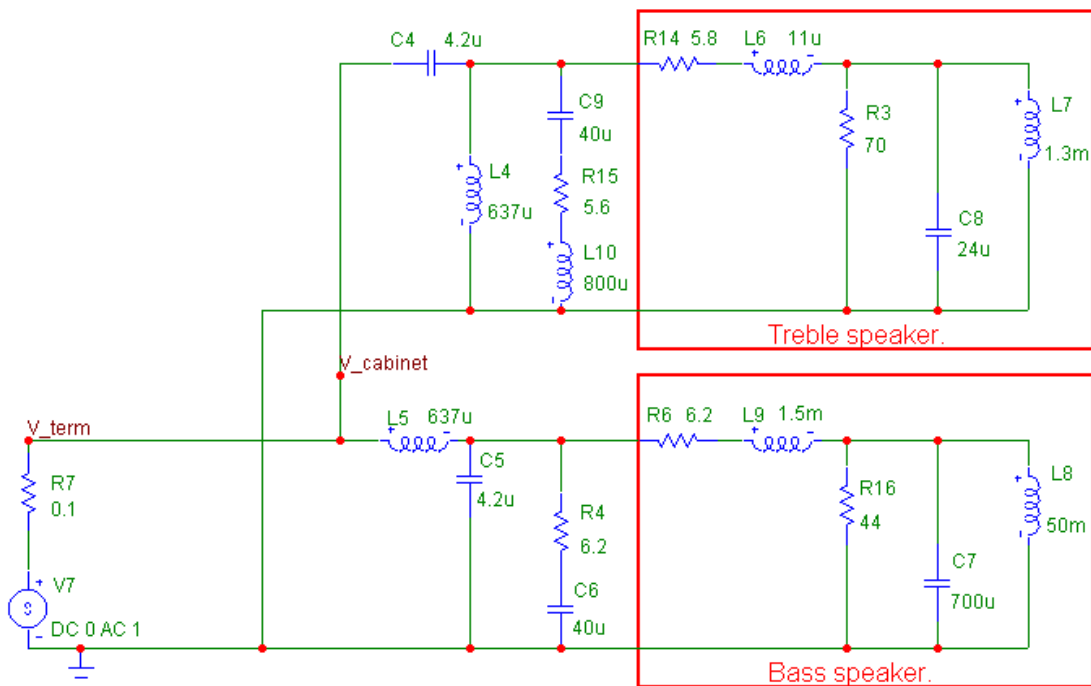

These distortion tests would require several quite noisy hours so to save my ears, I measured this ESP_replica assembly, for impedance and phase angle from 1kHz to 10MHz. At 1kHz this speaker system measured as 4.89Ω impedance with an inductive +11.3° phase angle. To approximate this 1kHz impedance I decided to use a 4.7Ω aluminium clad power wirewound resistor in series with a suitable aircored inductor, a value of 152.5μH would produce that phase angle. I had available a range of aircored inductors, 25μH, 54μH, 110μH and 250μH manufactured by Falcon Electronics, as supplied to UK speaker makers. For the initial experimental measurements, used a less reactive, more easily driven test load, the 25μH inductor with the 4.7Ω resistor, resulting in a modest +1.92° phase angle at 1kHz.

To ensure the amplifier and test rig performed correctly and obtain a baseline distortion reference using a D. Self amplifier, I measured distortion driving 1kHz at 3 volts into my 8.2Ω non-inductive test load, direct, no speaker cable. Second harmonic distortion was -95dB and third harmonic -98dB, while using the TDFD method, intermodulation distortion measured -87.1dB, or 0.004%. Using each test cable in

turn to connect this 8.2Ω resistive load, produced almost identical results. Less than 1dB distortion difference between the “with cable” and the “no cable” results.

At 3v with no cable the $4.7\Omega/25\mu\text{H}$ reactive test load measured rather worse, -89.5dB second -97.3dB third harmonic. Connected via 4.9metres (15ft) of 79 Strand cable, my lowest capacitance test cable with 71pF/metre, similar distortions were measured, -89.5dB second -97.5dB third harmonic, while 4.9metres of the medium capacitance, 203pF/metre, Supra 2.0 cable, produced identical results, -89.6dB second and -97.5 dB third harmonic. The TDFD analyser intermodulation distortions measured -82dB, -81.6dB respectively for these two commercial cables. With no measurable distortion differences for these cables, time now to measure using a rather higher capacitance cable.

I had available three 4.9metre (15ft) long development cables having nominal RF impedances of 30Ω , 16Ω and 14Ω . I selected the 14Ω impedance, my highest capacitance cable, labelled as #55. With 440pF/metre, it has slightly more than double the Supra cable capacitance, perhaps that might produce a measurable distortion difference. This #55 cable however presents a very modest capacitance compared to some commercially available cables which have more than 1500pF/metre.

With this #55 cable and 3 volts 1kHz drive into the $4.7\Omega/25\mu\text{H}$ test load, something was clearly wrong. Distortions increased almost 30 fold to now measure some -60dB second and third harmonic, so immediately switched off the power supply, but too late, both power supply rail 4A fuses blew as the amplifier disappeared in smoke. The output devices, several small signal devices, PCB tracks and five of the small signal section resistors were destroyed. The 100nF capacitor and 10Ω resistor in the Zobel network and the output inductor, when removed and measured, were undamaged.

This dramatic amplifier failure, driving less than 2 watts into this representative speaker test load, reminded me of a past failure of my Acoustic Research amplifier while auditioning several speaker cables. Comparing my standard 100Ω impedance cable in the left channel with this “#55 cable” in the right hand channel, the right channel of that amplifier too had overheated and failed.

I had failed to find any difference in amplifier/cable distortion driving into my 8.2Ω resistive load, but having now broken two quite different amplifiers, driving into an inductive load, time to revise my plans.

Failed Amplifier Investigation.

Using my HP4815A impedance meter, I measured this $4.7\Omega/25\mu\text{H}$ load for impedance and phase angle from 500kHz to 10MHz direct, no cable. Impedance increased up to resonance at 5.7MHz, reducing to 475Ω and -86° at 10MHz. I also measured the $4.7\Omega/110\mu\text{H}$ and $4.7\Omega/250\mu\text{H}$ loads over the same frequencies. The $4.7\Omega/110\mu\text{H}$ resonant frequency mimicked that measured for the ESP_replica assembly and the $4.7\Omega/250\mu\text{H}$ matched my two way horn loaded speaker resonance.

Measured via the 79 Strand cable the resonant impedance peak of the cable and $4.7\Omega/25\mu\text{H}$ load became 3600Ω at 1.8MHz, then reduced to a 5.8Ω low at 8.5MHz. With Supra cable this load measured 1600Ω at 1.185MHz falling to a 4.1Ω low at 7.8MHz. With my #55 cable, peak impedance was 1400Ω at 720kHz falling to a very low 1.1Ω at 7.65MHz, clear illustrations of how a cable can transform a mismatched, terminating load impedance. Similar resonant frequencies and high impedances could reasonably be expected when driving many speaker systems using 4.9metre long speaker cables.

To minimise the risk of damaging my sole remaining D. Self “Blameless” bipolar amplifier, I decided to monitor inside the amplifier using a pair of very high impedance, very low capacitance differential oscilloscope probes to input Channel B set at 20mV/cm, to observe any difference between the input and feed back differential input pair transistor base voltages. Channel A would monitor the amplifier output waveform using a conventional oscilloscope probe. I would again measure 1kHz output distortion but now using amplifier output voltages from 1v to 5v, in 1v steps.

Driving into this $4.7\Omega/25\mu\text{H}$ test load using 4.9metre lengths of the 79 Strand, Supra and my 30Ω RF impedance, $164\text{pF}/\text{metre}$ PTFE cable, these combinations all supported a 5 volts amplifier output with almost identical distortions and no sign of any amplifier distress, either on the differential input bases, output voltage oscilloscope traces or measured distortion.

Changing now to my second lowest impedance, the 16Ω RF impedance, $406\text{pF}/\text{metre}$ #44 cable, with 1 and 2 volts output all was well, with almost identical distortions to those of the previous cables. At 2.5 volts amplifier output, high frequency RF bursts of voltage became visible on channel B, monitoring the amplifier input/feedback pair transistor bases. Commencing slightly later than the output positive signal peak, this initial RF burst lasted for some $100\mu\text{s}$. Any further, small increase in drive level produced much larger amplitude, longer duration, bursts of RF. The output trace then exhibited similar high frequency bursts, with rapidly increasing distortion measurements.

Selecting an oscilloscope sweep speed of $10\mu\text{S}$ and using 10 times X trace width expansion, 2.5 cycles of RF occupied 1 cm of screen width, suggesting a 2.5MHz RF frequency.

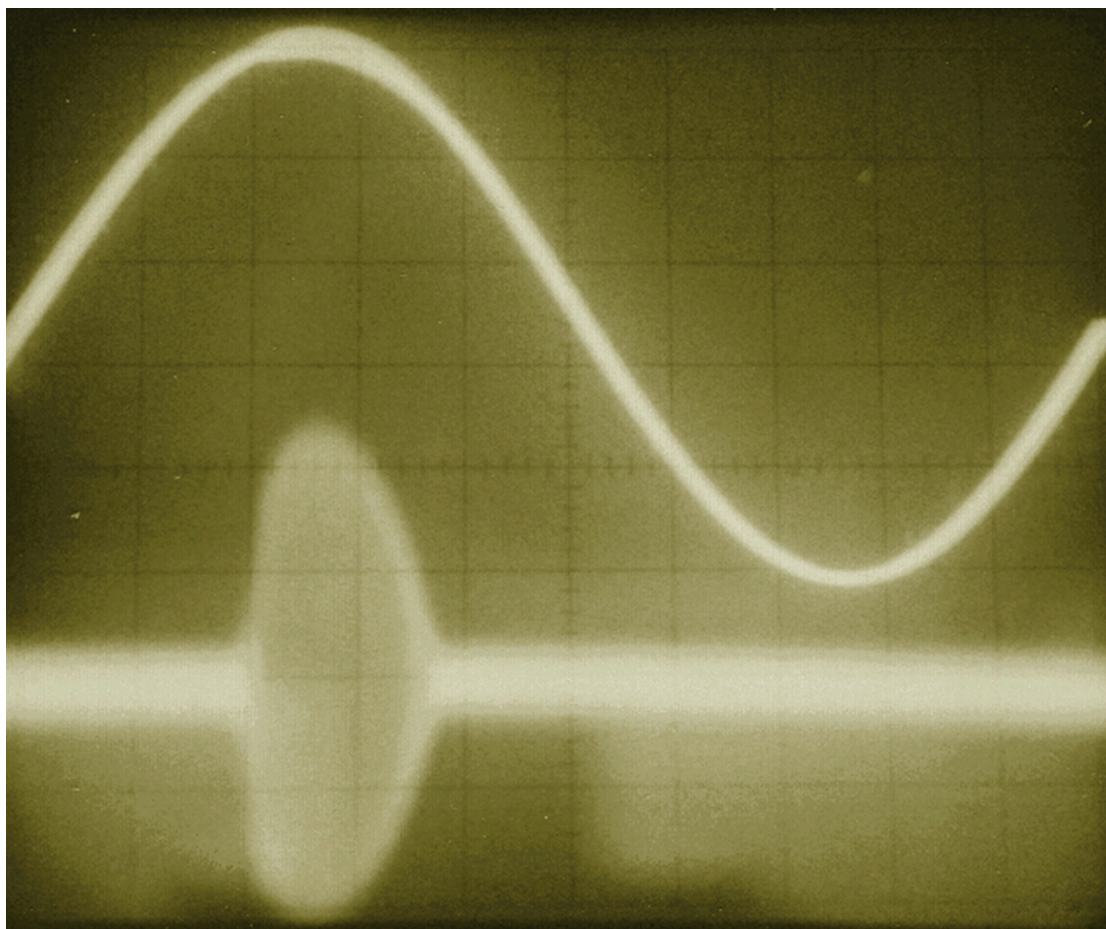

Figure 2. Replacing this #44 cable by my #55 cable, the same high frequency bursts were seen, but now occurring at lower voltage, at just 2.1 volts drive.

Channel B sensitivity was $20\text{mV}/\text{cm}$.

As far as I could measure, these RF oscillations occurred at 2.5MHz with both cables.

With small increases in drive voltage these RF oscillations increased in amplitude and remained visible for more of the cycle. With this particular amplifier, oscillations always initiated slightly after the peak of the positive output waveform but with increased drive then also appeared near the negative output peak, eventually becoming near continuous throughout the waveform. Compared with the Supra cable my #44 and #55 cables were both low impedance types but were not identical, so I had hoped to find a measurable difference in RF oscillation frequency, with change of cable.

Plotting the measured impedance and phase angles of this ESP_replica assembly together with values measured for my horn loaded speakers, initially direct with no cables then with each cable type in turn would illustrate the effect a change in cable has on load impedance with frequency. I used a Spice “one-port” or “Z_block”, containing tables of measured values of impedance and phase angle for my speakers, to be displayed on screen or be used with other components, in Spice simulations.

Fig 3.

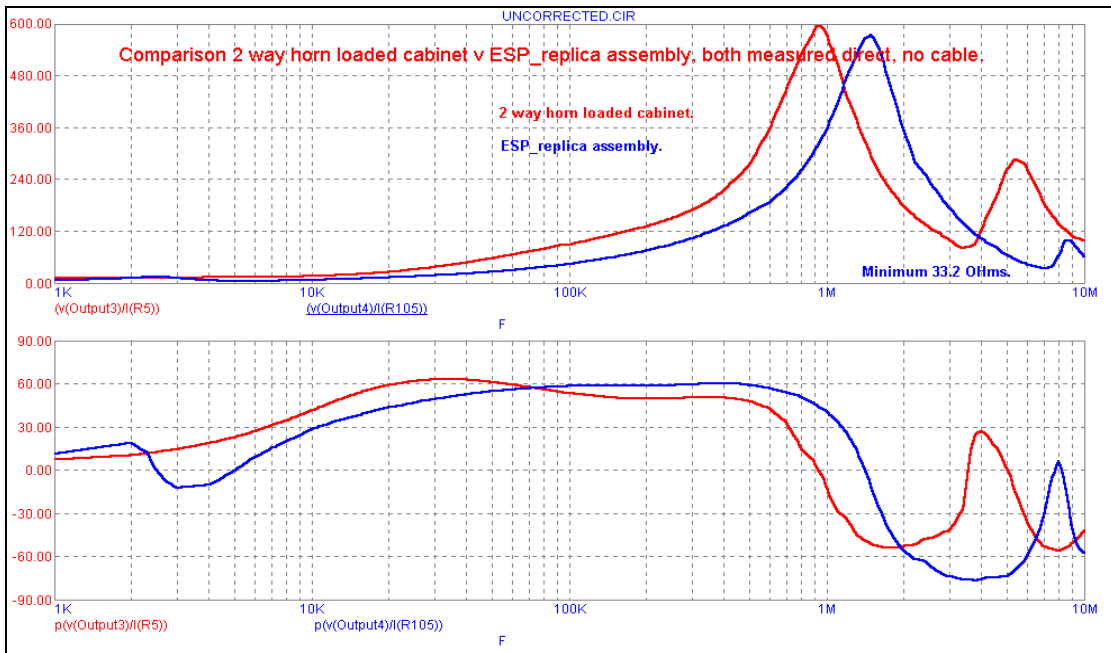

Figure 3. At 600Ω full scale, shows “no cable” values of impedance and phase angle as measured for my horn loaded & ESP_replica speakers. The Z_block model is used here as a display aid only.

Simulations would require a cable model usable from audible frequencies to say 10MHz. Cables are described using four frequency dependant AC parameters, series resistance R, series inductance L, shunt capacitance C and shunt conductance G.

$$\text{Cable } Z_0 = \sqrt{\frac{R + j\omega L}{G + j\omega C}} \quad \text{Equation 1. The Spice3}$$

transmission line model accepts only fixed values and only three of these four parameters so cannot be used, instead we are forced to use a number of “lumped” four component model stages. Many writers try to use quite small models, but to simulate to 10MHz, multiple stages are essential. I developed realistic Spice models using 201 frequency dependant four component nodes or stages, for each of my test cables. With these and the “Z_block” model I could now simulate the affect each cable had on my speakers.

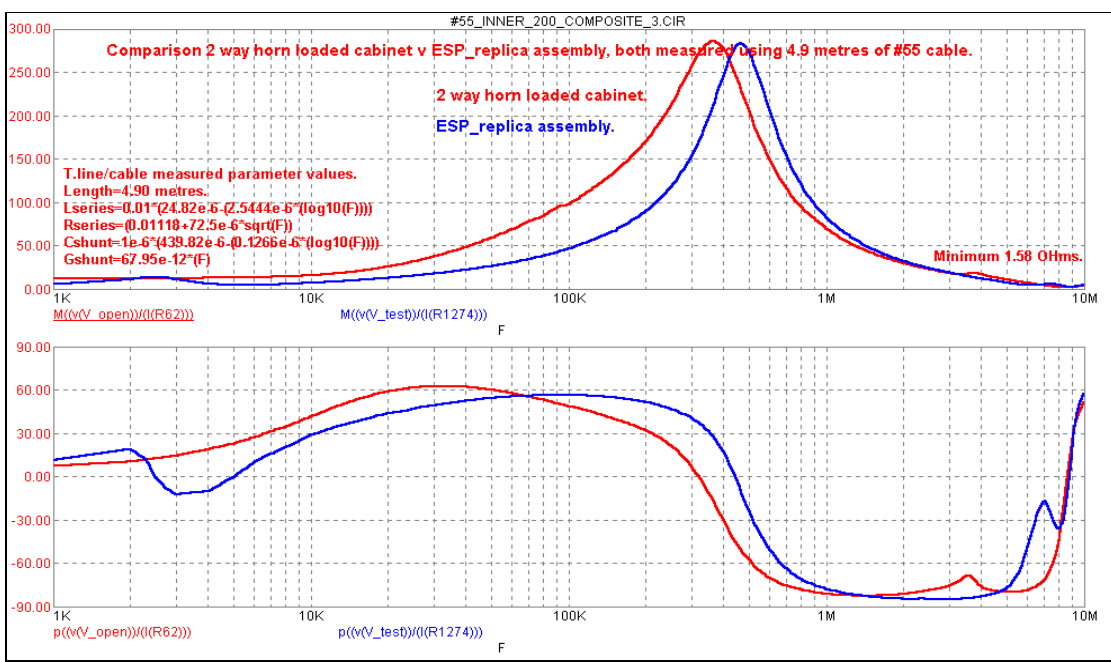

Figure 4. Now scaled 300Ω. With no cable the lowest HF impedance of both speakers measured as 33.2Ω. Using the #55 14Ω impedance cable we now find a 1.58Ω impedance is presented to the amplifier terminals at high frequency.

The resonant peak frequencies have also been significantly lowered in frequency and halved in impedance. The transition from inductive +ve to capacitive -ve phase angle, now occurs at a much lower frequency, well within the power bandwidth of many amplifiers. The 100Ω impedance 79 Strand cable has similar but smaller affect on both impedance and phase angle, more noticeably so with the ESP_replica assembly than with the lower resonant frequency horn loaded cabinets. Naturally the Supra and PTFE medium impedance cables produce similar but intermediate effects, between these #55 and 79 Strand test cable extremes. Higher capacitance/lower impedance cables produce even larger changes, noticeably also they increase speaker/cable load impedance at 20kHz.

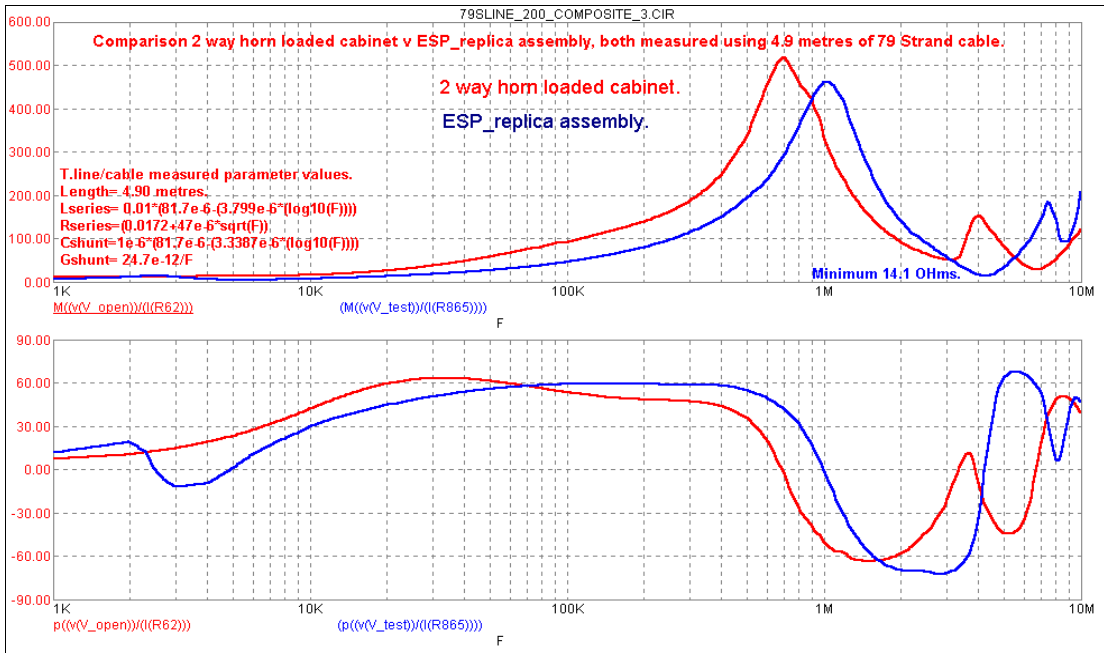

Figure 5. At 600Ω full scale, even the modest 79 Strand zip-wire cable affects impedance especially at 4MHz where the original minimum load impedance of 33.2Ω at 7MHz has been replaced by a new minimum of 14.1Ω.

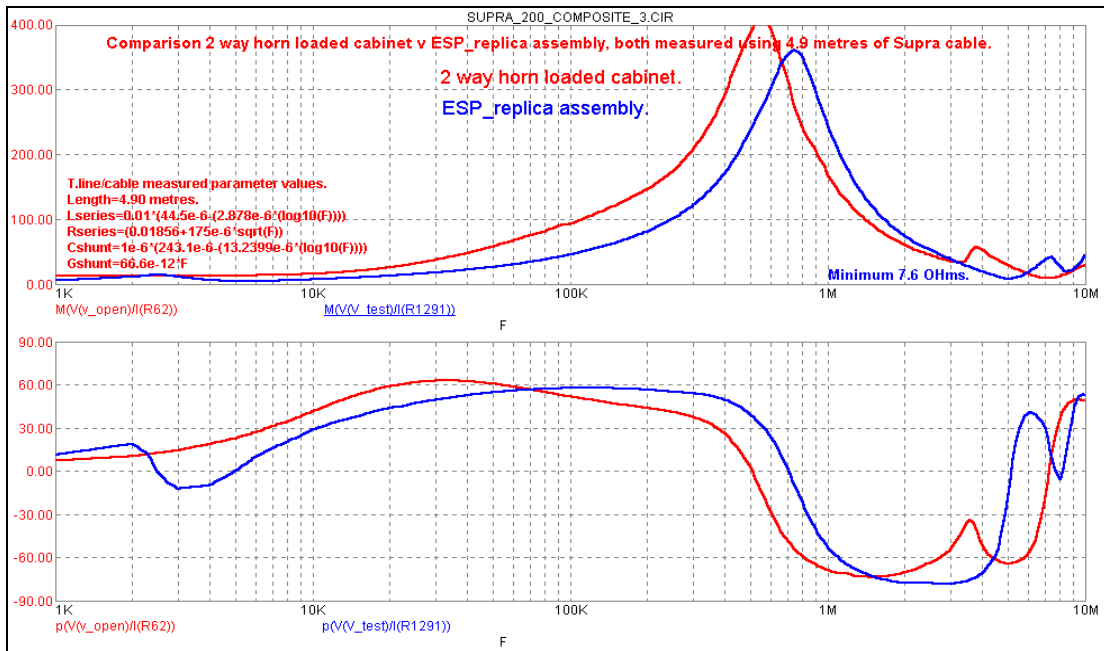

Figure 6. At 400Ω full scale. The Supra cable has less than half the impedance, inductance and more than double the capacitance of 79 Strand Zip-wire so speaker impedance and resonant frequencies are reduced more.

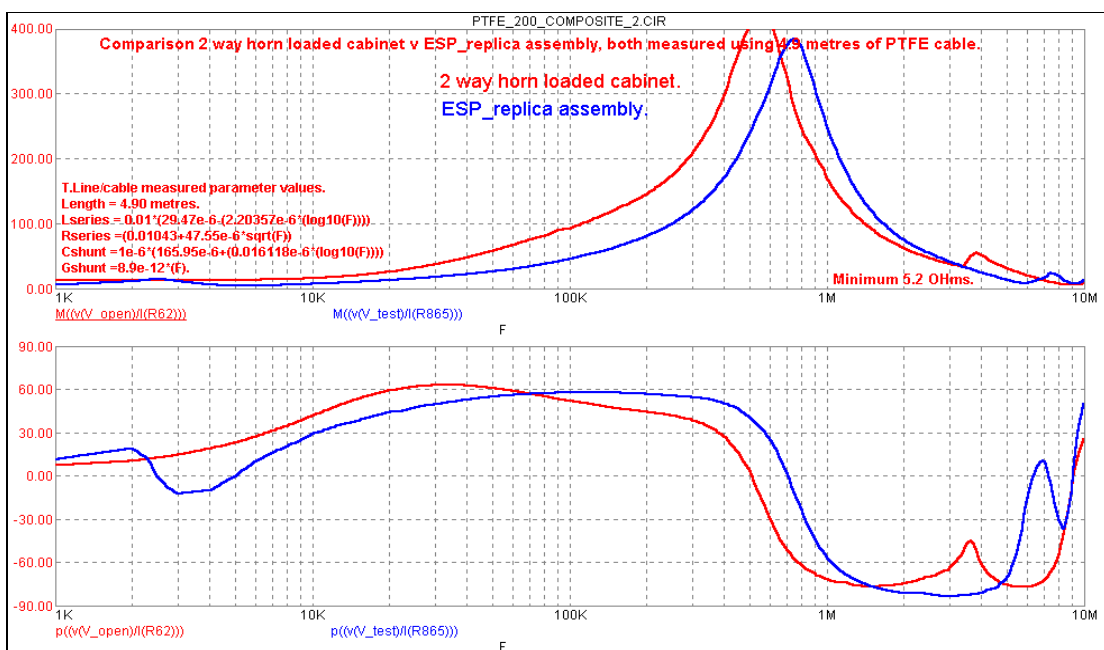

Figure 7. This very low loss PTFE cable, has 30Ω RF impedance compared with the Supra at 40Ω, but less capacitance and inductance, so similar speaker impedances and resonant frequencies except above 1MHz.

Cable characteristic impedance or Z0.

The characteristic impedance, Z0, of any cable is an AC parameter having a reasonably constant value above 1MHz, but at lower frequencies, Z0 increases rapidly, becoming near infinite near DC. At audible frequencies, characteristic impedance Z0 of any cable is many times higher than its high frequency value.

Many audio writers use the much simplified equation $Z0 = \sqrt{\frac{L}{C}}$, an approximation and only relevant at frequencies above 1MHz if using low loss insulators and values for L and C applicable to RF cables. It cannot be applied to any loudspeaker cable used at audio frequencies when values for R and G dominate.

The full cable **Equation 1**, $Z0 = \sqrt{\frac{R + j\omega L}{G + j\omega C}}$ is essential and is used throughout this paper. All four parameters are frequency dependant. R typically increases by the square root of frequency but even when using very low loss insulators, conductance G must increase rather more than this increase in frequency.

At audio frequencies, because R and G are dominant, not C or L, cable impedance is high but speaker system impedance in comparison is very low. With increase in frequency, speaker system impedance increases to very high values, typically more than 500Ω at resonance, for a speaker with or without a crossover, while speaker cable impedance reduces to a low value, typically rather less than 100Ω.

Speaker impedance increases to a peak of several hundred Ohms around 1MHz before reducing to around 100Ω by 10MHz. Between 1 and 10MHz it is usual to find at least one, lower impedance peak. Matching cable, amplifier and speaker system impedance at audible frequencies is not possible, but at high frequency we can explore the possibility and benefit, of improved high frequency matching.

Regardless of it's actual physical length, any cable matched or terminated by its characteristic impedance at that frequency, appears infinitely long, All energy entering the cable is absorbed and none reflected.

All 4.9metre long speaker cables become quarter wave resonant, between 8 and 11MHz dependant on the square root of the dielectric constant or "K" value of their insulation, which acts to slow down propagation speed within the cable. Cables longer than 4.9metres become quarter wave resonant at proportionally lower frequency. A quarter wave resonant cable acts to dramatically transform and can even invert the impedance of any "far end" load as measured at the cable's "near" or source end.

At this quarter wave resonant frequency, a cable with an open circuited far end reflects all energy arriving at this open circuit end back to the source, returning in phase with the incident energy. An open circuit can support no current so cannot dissipate any power. At the cable source end, the input impedance of this open circuited cable, now measures as a short circuit at that frequency.

With a short circuited far end, all energy is again reflected back to the source, but now out of phase with the incident energy, the input impedance at the source end of the cable now measures as an open circuit.

At frequencies above and below this resonance frequency, with real speaker loads, more complex impedance transformations now occur, which must be measured or calculated. see Appendix 1.

At exactly double this quarter wave resonance frequency, no transformation occurs, so input impedance at the source end of the cable now measures exactly the same as the terminating impedance.

Cable Reflections.

At much lower frequencies reflections do still occur with mismatched terminations, but produce less dramatic impedance changes. Reflections at 10kHz using the Supra cable driving the ESP_replica load are easily measured using a reflection bridge, the basic tool of all RF measurements. The figure shows some 40% of the incident signal has been reflected, equivalent to a VSWR of 2.2:1 and returned out of phase to the source. For this measurement I used my 50Ω HP8721A reflection bridges. Fig 8

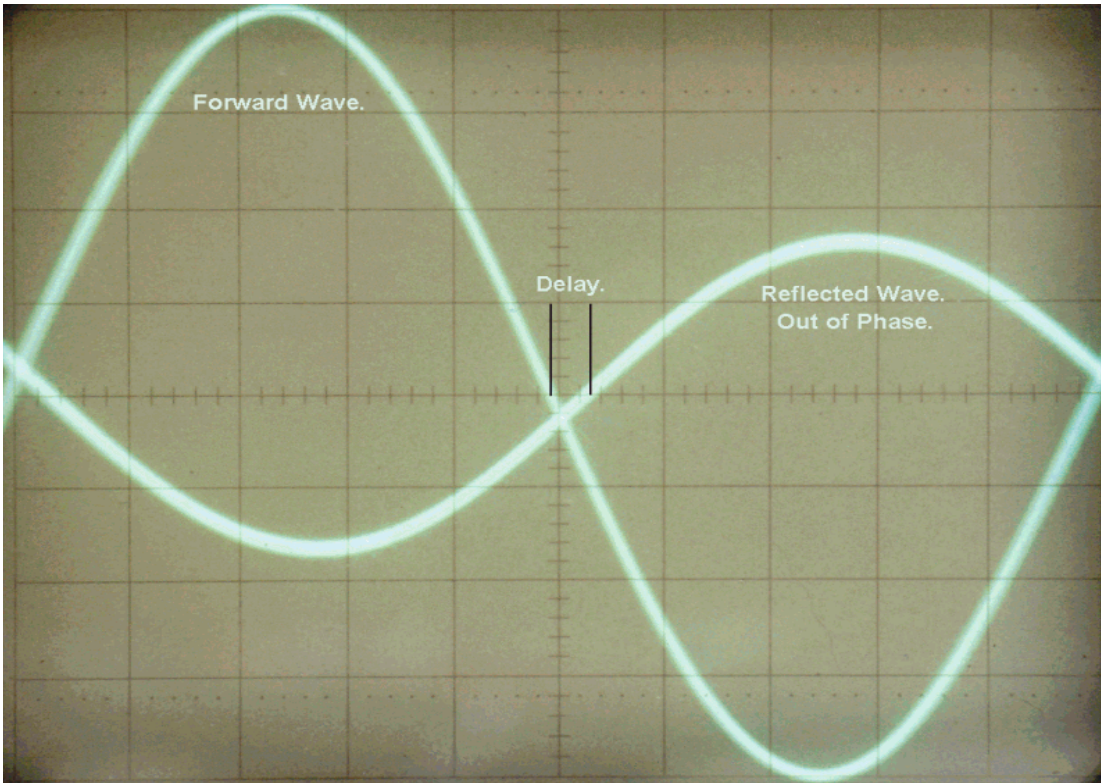

Figure 8. Open and short circuit terminations are extreme conditions. Any non-Z0 termination impedance even at audio frequencies as shown here at 10kHz, results in a reflected wave having an amplitude and polarity dependant on the degree of mismatch.

The ratio of this reflection to the incident signal or $\frac{V_{\text{reflection}}}{V_{\text{incident}}}$ is called the reflection coefficient and calculated as (rho) or $\rho = \left(\frac{Z_L - Z_0}{Z_L + Z_0} \right)$ where Z0 is the cable characteristic impedance at that frequency. At 10kHz Supra Z0 is 49.6Ω, ESP_replica speaker approximates 6.6Ω. At audio frequencies, cable/speaker mismatch results in a negative value for ρ. Regardless of cable length, reflections are returned out of phase with the forward signal. It is not possible to reduce these audio frequency mismatch reflections.

With increasing frequency, as speaker impedance increases and cable Z0 reduces, we reach a crossover point with no reflections at that frequency while both impedances remain equal. At higher frequencies speaker impedance then exceeds cable Z0 so reflections are now returned in phase, have the same polarity, as the forward signal at the cable far end. A mismatch of 2:1 or reflection coefficient of 0.33, is generally considered the maximum acceptable level for RF designs.

Ideally our amplifier will not produce any power at these in phase frequencies, otherwise strong oscillations may result. However since the loudspeaker load impedance now exceeds the cable's characteristic impedance, improved matching becomes possible, to minimise high frequency reflections.

We can use Spice to calculate and plot the cable Z0 by frequency, either by inserting the cable's measured parameters into **Equation 1** or by using my frequency dependant, 200/01 nodes, lumped cable model. We can then model the impedance of both cable and speaker to calculate and display reflection coefficients using the above equation for ρ. Unity indicates a 100% reflection, a positive ρ value indicates reflection in phase/same polarity with the forward signal, a negative ρ value indicates a reflection returned out of phase/opposite polarity with the forward signal, at the cable far end.

Starting with the #55 cable we find large, nearly 100%, in phase, same polarity reflections do occur between 700kHz and 3MHz, changing from negative to positive phasing at high audio frequencies. Should the amplifier produce any unwanted higher frequency signals the speaker cable end mismatch will produce an in phase reflected voltage at the amplifier terminals, with amplitude determined by cable losses and reflection coefficient, delayed only by the cable end, load phase angles and cable transit times.

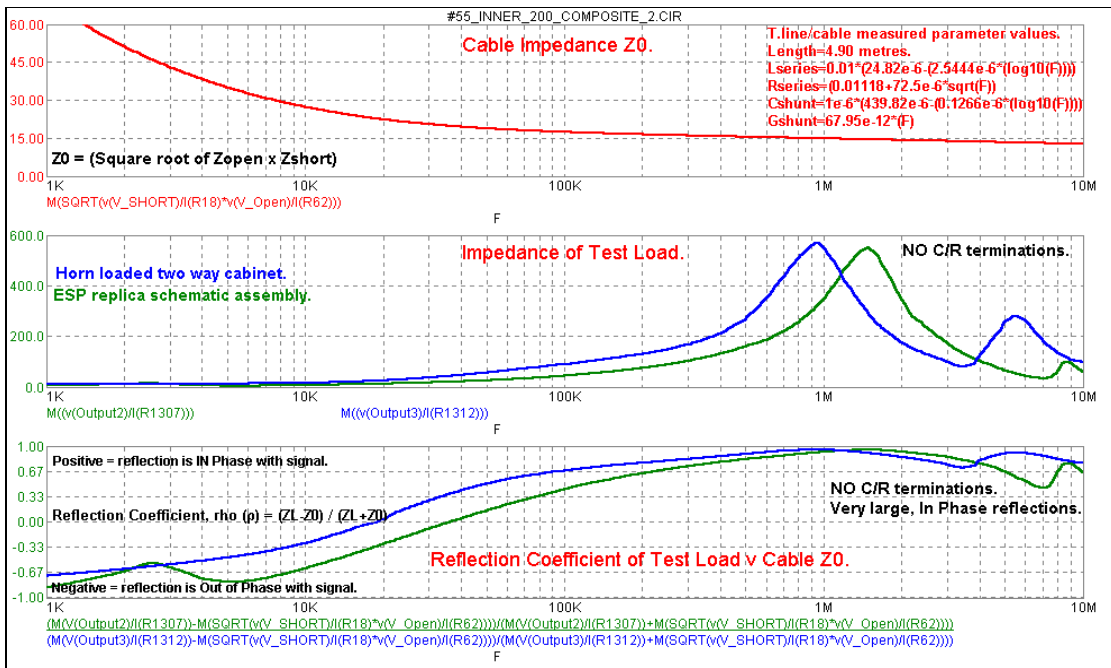

Figure 9. Using 600Ω full scale, the 575Ω ESP_replica peak impedance at 1.5MHz with #55 cable, results in a reflection coefficient of 0.95, reflecting 95% of any incident signal over many frequencies, in phase back to the amplifier.

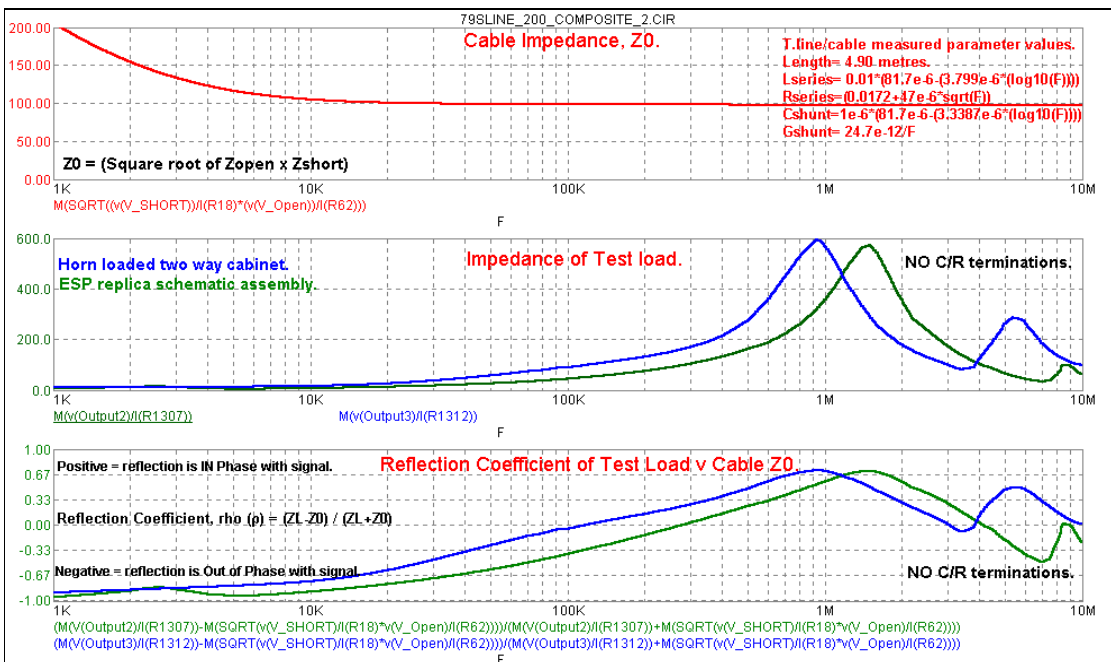

Figure 10. Looking now at the 100Ω impedance 79 Strand cable we see this cable is much better behaved with both our speakers. Maximum in phase reflections are less than 80% and over fewer frequencies.

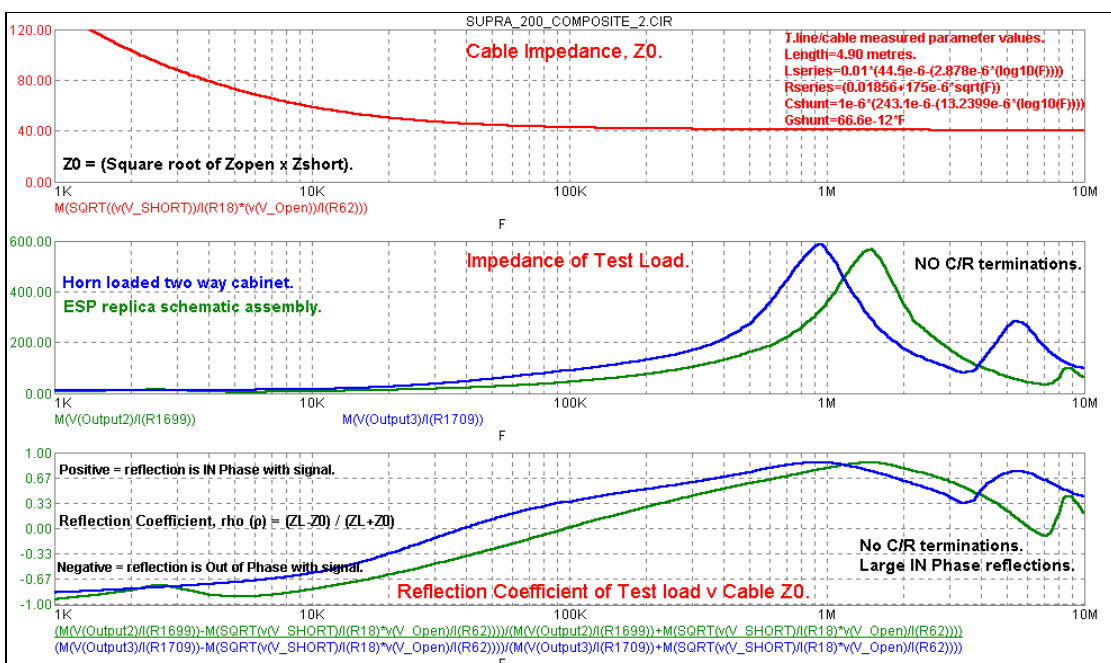

Figure 11. With the medium impedance Supra cable we find reflection coefficients midway between these two cable extremes.

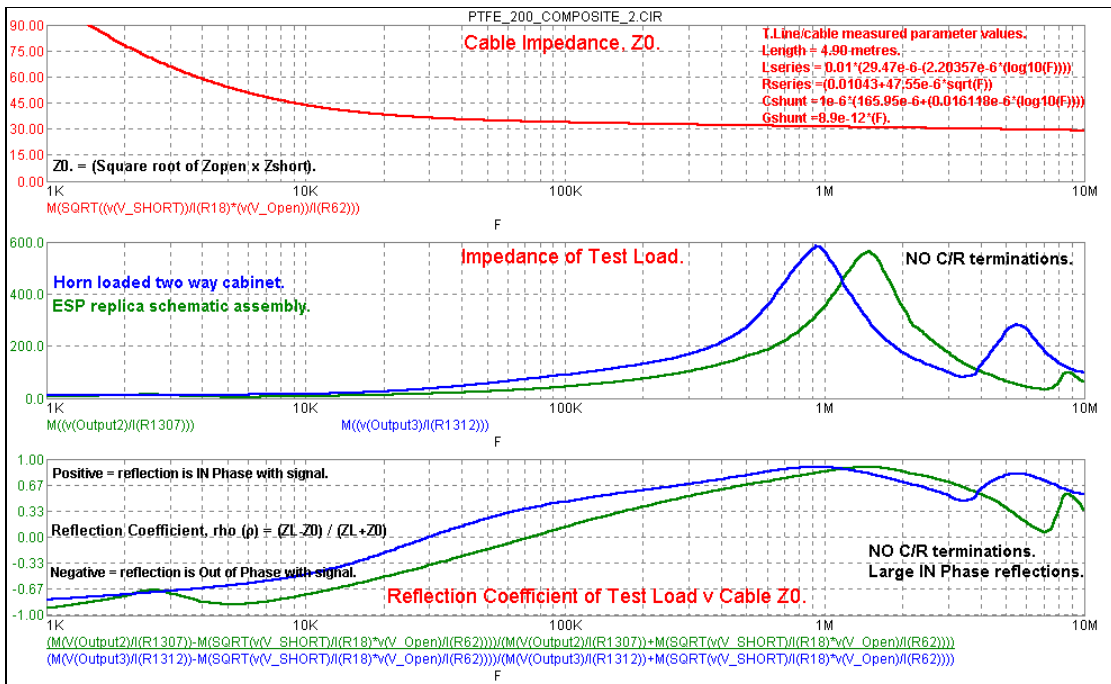

Figure 12. Major in phase reflections of 85 to 90% using the PTFE cable but again over fewer frequencies, more like the 79 Strand than the low impedance #55 cable frequency pattern.

After allowing for the two way cable losses and transit delays, a large, near 100% in phase signal reflection will appear at the amplifier output terminals. It remains to be seen later, how well or badly the amplifier Zobel network, output inductor and amplifier output impedance at 1MHz and above, combine to prevent these undesired reflections from entering inside the amplifier.

So far we have only simulated these in phase RF reflections and not proven them by measurements. But accepting that these reflections do occur, can anything be done to minimise in phase reflections. Let us now see how we may improve the high frequency cable speaker matching, to reduce in phase reflections at high frequencies. At 1MHz self inductance of resistors and capacitors matters and cannot be ignored.

We could add a resistor across the speaker terminals to set a limit on the speaker maximum impedance, but to be effective that resistor would have to absorb significant audio frequency power and be non-inductive at high frequency, a difficult almost impossible choice, wirewound types exhibit far too much self inductance. Using a small value series capacitor to reject the audio power allows using a 1-2 watt, low inductance, film resistor. We can explore the effect of using terminating resistance slightly larger and smaller than the cable RF impedance, using the Spice “stepping” function.

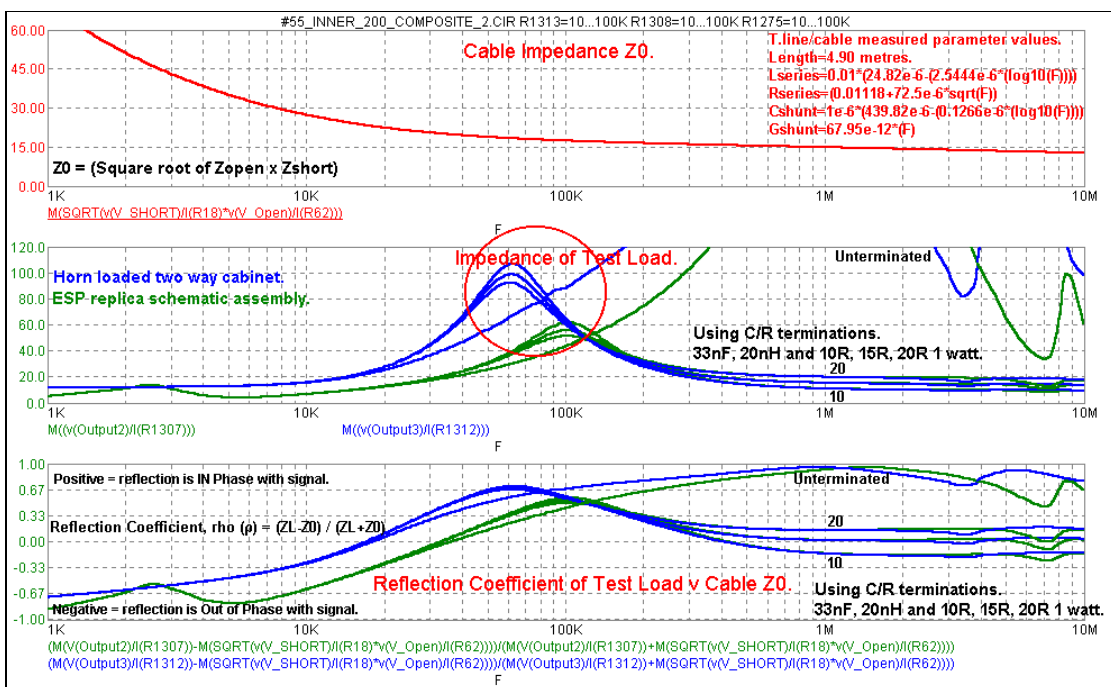

Fig 13 Using a 33nF capacitor and resistor to remove these high frequency reflections we find increased cable/speaker impedance commencing at high audio frequencies. Some writers have advocated using a 100nF capacitor, but that seriously degrades treble response.

Comparing this result with figure 9, using a 33nF capacitor with 10Ω, 15Ω, 20Ω resistors and self inductance estimated at 20nH we see an immediate benefit at high frequencies. The original near unity reflection has been replaced by near zero reflections above 250kHz. However this capacitance value now reacts with the cable and speaker impedances resulting in increased impedance and reflections at high audio frequencies. Combined with a typical 1-1.5μH amplifier output inductor, results in a measurable loss of treble, especially so for my horn loaded cabinets. The effect of using any larger capacitance C/R such as 0.1μF would be audible with many speaker systems. For some years, following my Acoustic Research amplifier damage, I adopted a similar C/R termination on the horn loaded speakers. My ears were too old to notice, but this reduction in high end treble was remarked on by my musician son.

Can reduced high frequency reflections be obtained without impacting on audible frequency load impedance ? Suppose we use a shunt resistor say ten times larger value than the speaker impedance at audio frequencies, we could try using say 100Ω. That resistor would then only be subject to one tenth of the audio power, say 5 watts maximum. On its own that would not provide sufficient improvement at high frequency so we still need to use the C/R technique. Would we now need to use a larger value resistor to compensate for the shunting effect of this added 100Ω device ?

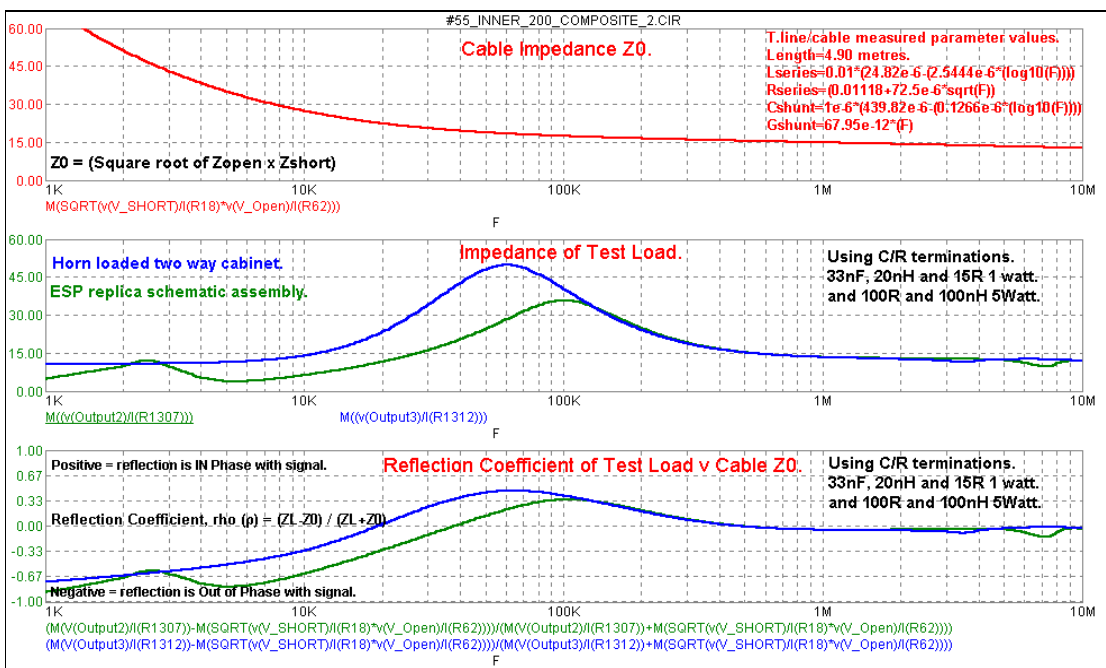

Figure 14. Including a non-inductive 100Ω resistor with no series capacitor has dramatically reduced the impedance peak between 20kHz and 100kHz to less than half. Impedance at high audible frequencies is not affected.

Using the original 33nF capacitor and 15Ω resistor with 20nH self inductance (2.5cm leadwire), together with a 100Ω shunt resistor having less than 100nH self inductance has eliminated high frequency reflections with both speaker systems and halved the previous horn loaded cabinet/cable low frequency impedance hump from 100Ω down to 50Ω without influencing impedance at high audible frequencies or treble response. In addition it has reduced the ESP_replica impedance hump and reflection coefficient of 0.55 at 100kHz, shown in figure 13, to a near reflection coefficient of 0.33, for a 2:1 mismatch.

Does any 5 watt capable resistor exist which is sufficiently non-inductive - well yes. Some time ago I needed a 100Ω non-inductive 5 watt resistor. The solution was to use one of the new TO220 packaged 1 watt resistors which can support up to 20 watts when mounted on a suitable heat sink. When I measured Farnell part no 551-594, its resistance value remained at 100Ω at 1MHz.

Can this technique be applied to other cables, yes apart from the 79 Strand and similar high impedance cables which need only use a 10nF capacitor with a 100Ω film resistor. Reflections from the Supra 40Ω impedance cable were minimised by using an 18nF capacitor with 68Ω resistor C/R network and this shunt 100Ω resistor, while for the PTFE 30Ω impedance cable I choose an 18nF capacitor and 42Ω resistor, again used with the 100Ω shunt resistor.

Figs 15, 16 17.

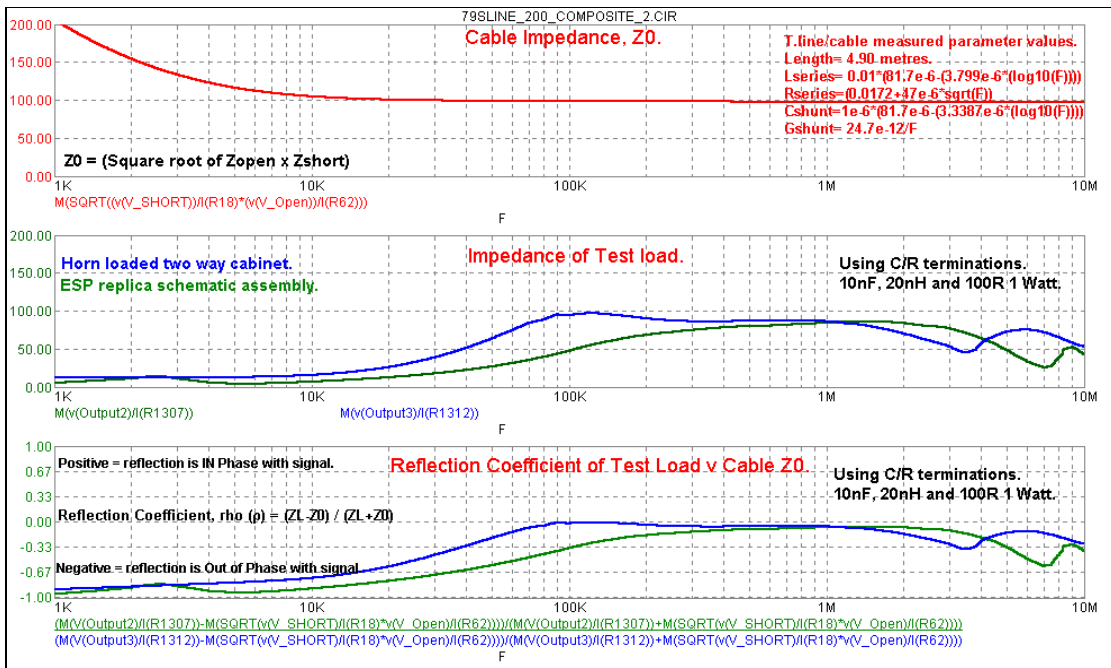

Figure 15. Because the 79 Strand cable is 100Ω Z₀ at RF we need only use the 10nF/100Ω C/R network. That works far better than using the 100Ω resistor on its own and no C/R. No in phase reflections at any frequency.

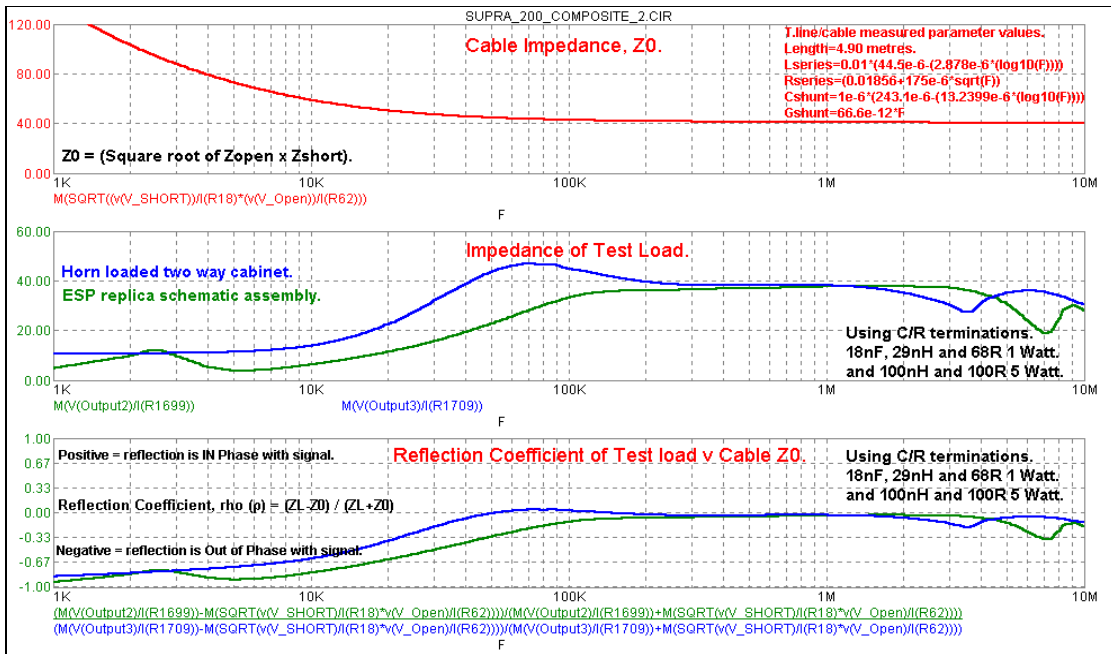

Figure 16. With medium impedance Supra cable, the combination of a parallel 100Ω resistor, with an 18nF 68Ω C/R combination provides the desired control of reflection coefficient at all frequencies.

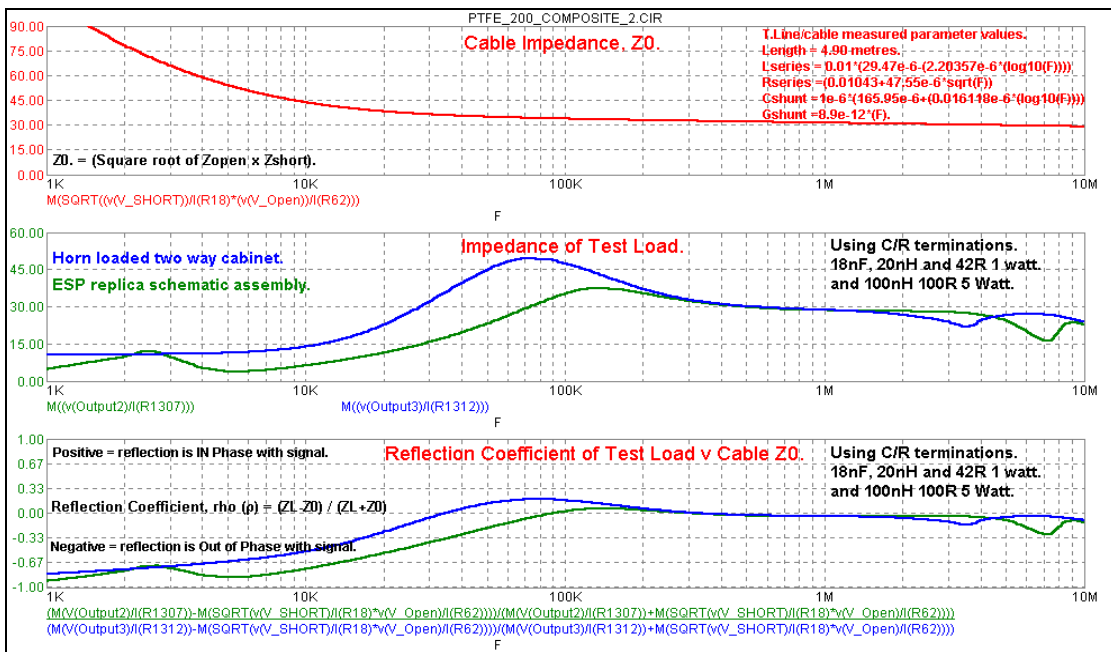

Figure 17. We can now select optimum capacitance and resistor values needed for high frequencies, without impacting on the above audible frequency performance. In this case 18nF/42Ω with the 100Ω.

Clearly the lowest speaker end cable reflections, best high frequency match occurs when using the 100Ω shunt resistor in parallel with a C/R network, for cables having less than 100Ω RF impedance, when this network in parallel with 100Ω and the speaker high frequency impedance, approximates the cable high frequency impedance, Z_0 .

I said earlier that at audible frequencies, because the cable impedance was so much higher than the speaker impedance, out of phase reflections would be returned back to the amplifier output terminals from the speaker and that nothing could be done to prevent this. Do these audible frequency reflections matter. ?

At audible frequencies, the amplifier output impedance presents an exceptionally low load impedance compared to the cable Z_0 . These out of phase reflections will not enter the amplifier but will be reflected and phase inverted, becoming in phase with and absorbed in the amplifier output signal, delayed by twice the cable transit time plus any load phase angle.

Assuming our typical 4.9metre length cable, this two way transit time will approximate 50nS equivalent to just 0.36° at 20kHz, or 0.018° at 1kHz.

So much for the theory and simulations, time now in part 2, to try out these solutions in practical measurements, using both the Self bi-polar and the Maplin mosfet amplifiers, my test cables, the ESP_replica assembly and reactive test loads, with output voltages from 1 to 5v in 1v steps.

ref.1 Capacitor Sound, C. Bateman Electronics World July 02, September 02 thru January 03.

Appendix 1. Modelling Audio Cables.

Earlier when discussing the cable **Equation 1**, when $Z_0 = \sqrt{\frac{R + j\omega L}{G + j\omega C}}$ I stated that all four AC parameters, G, R, L and C were required when modelling cables at audible frequencies, yet many writers have used the much simplified, constant value, RF expression for Z_0 , $Z_0 = \sqrt{\frac{L}{C}}$ at audible frequencies.

At frequencies of 1MHz and above this simplification works pretty well provided we use low loss dielectric cable insulation, such as PTFE or Polythene with the typical capacitances used for RF cables, e.g. 50 or 75pF/metre. At 1MHz, L and C then dominates over the contribution made by G and R.

At low audio frequencies and especially using lossy dielectric cable insulation such as PVC and much larger capacitance values, this simplification does not apply. G and R now dominate over L and C giving a simplified low audible frequency expression, $Z_0 = \sqrt{\frac{R}{G}}$ for mathematical proof see Line

Communications vol.1. p.738.

N.B:- G is the cable AC conductance, measured in Siemens and not its DC insulation resistance.

Z_0 is easily found for any frequency simply by measuring the cable's impedance with far end open circuit, for Z_{open} , then with far end short circuit, for Z_{short} , when $Z_0 = \sqrt{Z_{short} \times Z_{open}}$.

Measured Z_0 for my cables at 100Hz ranged from 600Ω for 79Strand, 350Ω for the Supra 2.0 cable to 200Ω for my lowest impedance #55 cable. At 1MHz, these three cables were measured as 97.2Ω, 41.6Ω and 13.5Ω respectively. At audible frequencies calculating Z_0 , using $Z_0 = \sqrt{\frac{L}{C}}$ is clearly not valid.

Most writers emphasise the affect skin resistance has on cable resistance at high audio frequencies, increasing typically according to the square root of frequency. More important however is G, which even using the most perfect insulation, must increase at least by the increase in frequency. We are all familiar with the use of ESR with capacitors, the small value of resistance in series with a capacitor, used to account for the capacitor phase angle being less than the theoretical 90° due to the imperfect dielectric insulation used. This same phase angle can also be represented as a very large value resistor in parallel with the capacitor. When calculating cable parameters it is usual to use the reciprocal value of this shunt resistance, now called conductance G and measured in Siemens (1/Ω), measured at AC and not DC.

Capacitance, resistance and inductance also vary with frequency, depending on the cable insulation and wire dimensions used. As a result to model from audible frequencies to 1MHz and above we are forced to use all four parameters, each being frequency dependant, so cannot use the Spice3 transmission line model. Perhaps some example measurements made with two of my cables will clarify these points:-

Freq.	Supra					PTFE				
	G μ S	R	Cpf	L μ H	Z Ω	G μ S	R	Cpf	L μ H	Z Ω
1kHz	0.298	0.0926	994	1.8	114.6	0.0047	0.060	804.3	1.1	91.5
10kHz	3.76	0.0937	905.2	1.78	49.6	0.05	0.0636	801.5	1.04	40.5
100kHz	42.7	0.17	820	1.78	45.6	1.67	0.123	800.0	0.88	33.3
2MHz	651.5	2.07	780	1.46	41.6	87.0	0.6	820	0.72	29.5

All cable models used for these simulations used 201 R, L and 200 G, C stages, based on the above values divided by 201 or 200 respectively and frequency dependant equations.

While Z_0 can be calculated from the above table, it is much easier to copy the cable makers method. Measure cable impedance with far end open circuit, then short circuited, when $Z_0 = \sqrt{Z_{short} \times Z_{open}}$.

Cable measurements/models.

Cable Equations used in Spice simulations, each 201/200 nodes.

PTFE cable. (Measured Zo @ 1kHz, 91.5Ω. @ 10kHz, 40.5Ω @ 1MHz, 29.5Ω.)

T.Line values used for each node.

Lseries, $4.9/201 * 0.01 * (29.47e-6 - (2.20357e-6 * (\log_{10}(F))))$

Rseries, $4.9/201 * (0.01043 + 47.55e-6 * \sqrt{F})$

Cshunt, $4.9/200 * 1e-6 * (165.95e-6 + (0.016118e-6 * (\log_{10}(F))))$

Rshunt, $2.90508e12/F$

Supra cable. (Measured Zo @ 1kHz, 114.6Ω. @ 10kHz, 49.6Ω @ 1MHz, 41.6Ω.)

T.Line values used for each node.

Lseries, $4.9/201 * 0.01 * (44.5e-6 - (2.878e-6 * (\log_{10}(F))))$

Rseries, $4.9/201 * (0.01856 + 175e-6 * \sqrt{F})$

Cshunt, $4.9/200 * 1e-6 * (243.1e-6 - (13.2399e-6 * (\log_{10}(F))))$

Rshunt, $6.1285775e11/F$

79 Strand. (Measured Zo @ 1kHz, 178Ω. @ 10kHz, 103.6Ω @ 1MHz, 97.2Ω.)

T.Line values used for each node.

Lseries, $4.9/201 * 0.01 * (81.7e-6 - (3.799e-6 * (\log_{10}(F))))$

Rseries, $4.9/201 * (0.0172 + 47e-6 * \sqrt{F})$

Cshunt, $4.9/200 * 1e-6 * (81.7e-6 - (3.3387e-6 * (\log_{10}(F))))$

Rshunt, $1.6525e12/F$

#55 cable. (Measured Zo @ 1kHz, 61.7Ω. @ 10kHz, 24.1Ω @ 1MHz, 13.5Ω.)

T.Line values used for each node.

Lseries, $4.9/201 * 0.01 * (24.82e-6 - (2.5444e-6 * (\log_{10}(F))))$

Rseries, $4.9/201 * (0.01118 + 72.5e-6 * \sqrt{F})$

Cshunt, $4.9/200 * 1e-6 * (439.82e-6 - (0.1266e-6 * (\log_{10}(F))))$

Rshunt, $6.00682e11/F$

#44 cable. (Measured Zo @ 1kHz, 63.5Ω. @ 10kHz, 25Ω @ 1MHz, 15.6Ω.)

T.Line values used for each node.

Lseries, $4.9/201 * 0.01 * (25.878e-6 - (2.5789e-6 * (\log_{10}(F))))$

Rseries, $4.9/201 * (0.0109796 + 72.6e-6 * \sqrt{F})$

Cshunt, $4.9/200 * 1e-6 * (412.2e-6 - (2.12989e-6 * (\log_{10}(F))))$

Rshunt, $4.00317e11/F$

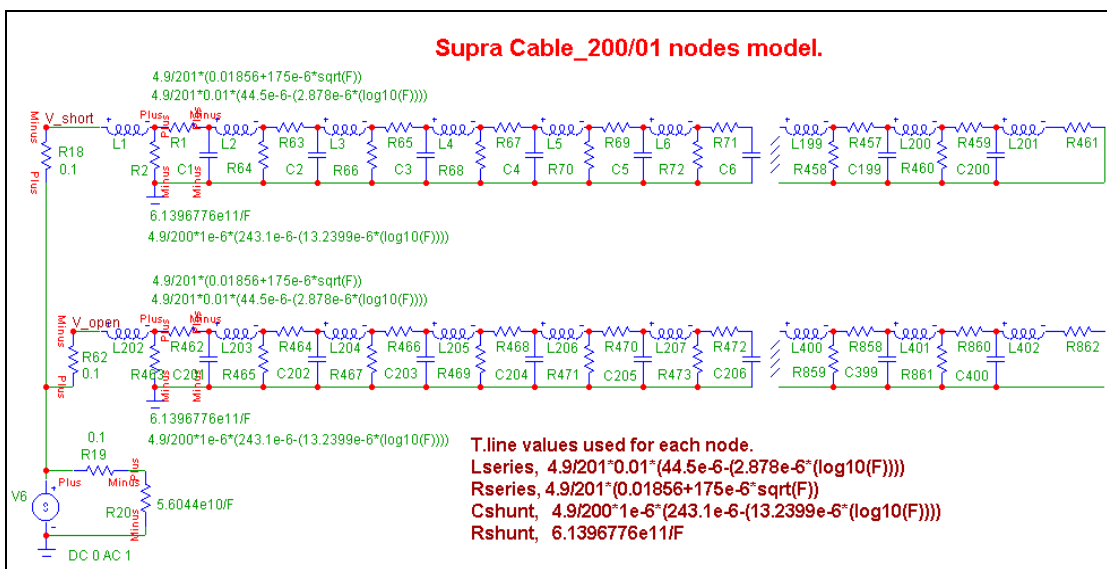

Cable A. Schematic used to develop cable models to R, L, C and G measurements, ZO and quarter wavelength resonant frequency. For speaker simulations, use one only of these two lines.

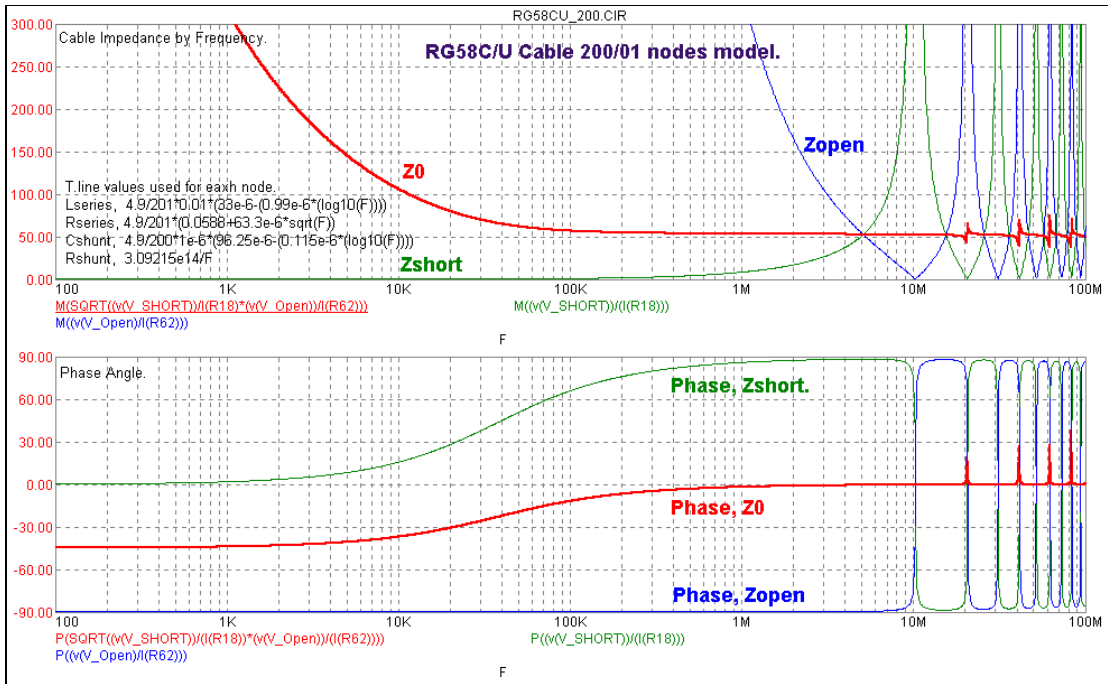

Cable B.
To prove this 201/200 node model was valid up to 10MHz, it was initially used to model against 4.9metre of pre-measured RG58U coaxial cable, checking for Z0 by frequency also quarter wave resonance impedance and frequency.

Spice “One Port” or “Z_block” model subcircuit as used in simulations.

```

$ ESP replica crossover measured Direct, impedance and phase.
$ No amplifier zobel or cable used.
$ Impedance magnitude and phase measured.
$ Frequency checked using freq counters.

.define ListVal (0,0,0)
+(1000,4.89,11.3)
+(2000,10.61,19)
+(2300,13.1,12)
+(2470,13.49,1)
+(2700,13.2,-7)
+(3000,10.77,-12.6)
+(4000,5.48,-10.6)
+(5000,3.92,-0.8)
+(6000,4.01,9.3)
+(7000,4.51,15.6)
+(8000,5.20,20.4)
+(9000,5.86,24.4)
+(10000,6.58,28.8)
+(11000,7.18,31)
+(12000,7.83,33.5)
+(13000,8.41,35.2)
+(14000,8.98,36.6)
+(15000,9.56,38)
+(16000,10.11,39.6)
+(17000,10.66,40.8)
+(18000,11.20,42)
+(19000,11.75,43)
+(20000,12.31,44)

```

ESP replica crossover, no cable, no zobel, measured direct
F*v(Out1)*v(Out-3)/F
Z_Block (Impedance_Mag/Phase)
Frequency Domain Analysis ONLY.

This Z_block model allows a CSV listing of measured frequency, impedance and phase angle parameters, to be displayed on screen or used together with other components in Spice simulation.

You may wonder why I choose to use the above Z_block to represent both my test speakers, why not simply model their schematics using Spice ? At audible frequencies that can work quite well, however at higher frequencies every component used, whether inductor, resistor, capacitor and especially so the speaker drivers, for accuracy must use complex, multicomponent models, to match resonant frequencies. Every inductor or speaker voice coil includes significant self capacitance and resonant frequency peaks and troughs. Simplistic Spice simulation of this schematic, shows impedance continually increasing with frequency quite unlike the measured values resonant peaks and troughs, so leads to false conclusions.

Accurately measuring both speaker systems and inputting measured values of impedance and phase angle by frequency into the Z_block as shown, is quicker, simpler and most important, is error free. Combined with my proven cable models, then produces the most accurate simulations possible, for this complex speaker with cable, behaviour. Clearly as figures 3 through 12 have shown, speaker cables do comply with established transmission line behaviour.

Cables, Amplifiers and Speaker interactions. part 2.

Final version.

Cyril Bateman investigates a cause of audible distortion and amplifier failures. In confidence, not yet published.

Simulations in part 1 suggested a possible method whereby above audible frequency reflections caused by high frequency speaker impedance vastly exceeding that of our loudspeaker cables, could be minimised. This solution required the use of carefully chosen resistor capacitor impedance correcting networks affixed to the speaker terminals. So much for theory and simulations, time now to prove these solutions in practical tests using both the Self bi-polar and the Maplin mosfet amplifiers, my test cables with the ESP_replica assembly and R/L reactive test loads, using amplifier output voltages from 1 to 5v.

Initially using unterminated cables up to the voltage when RF bursts first become apparent, then complete each test, using the relevant C/R cable end termination while recording second and third harmonic distortions. Finally using this C/R termination network, increase output voltage in steps until RF bursts become apparent or the amplifier rated output current is attained.

Cable Reflections.

As a final cross-check, I would observe the reduced reflections produced using this C/R termination network, using an easily assembled directional coupler, switchable so as to measure at the impedances needed for each of my cables. This coupler assembly is fully described later, see figure 38.

Using my two channel oscilloscope, photograph the reflected waveforms for each test cable, driving into the ESP_replica speaker assembly, using both 4.9 and 10metre cable lengths. Initially with the cable end unterminated at 10kHz and 1MHz, then at 1MHz with the cable terminated, using the C/R values shown in figures 14 through 17, in part 1. Finally with the cable terminated, sweep the test frequency from 100kHz to 5MHz, while observing these waveforms.

With no C/R termination and using the ESP_replica assembly as load, the measured reflections had large amplitudes, hardly smaller than the drive signal, exactly as shown in the simulation figures 9 through 12, in part 1. More significantly for most frequencies, from typically 150kHz to 3MHz, the reflected wave was seen to be clearly in phase with, have the same polarity, as the drive signal.

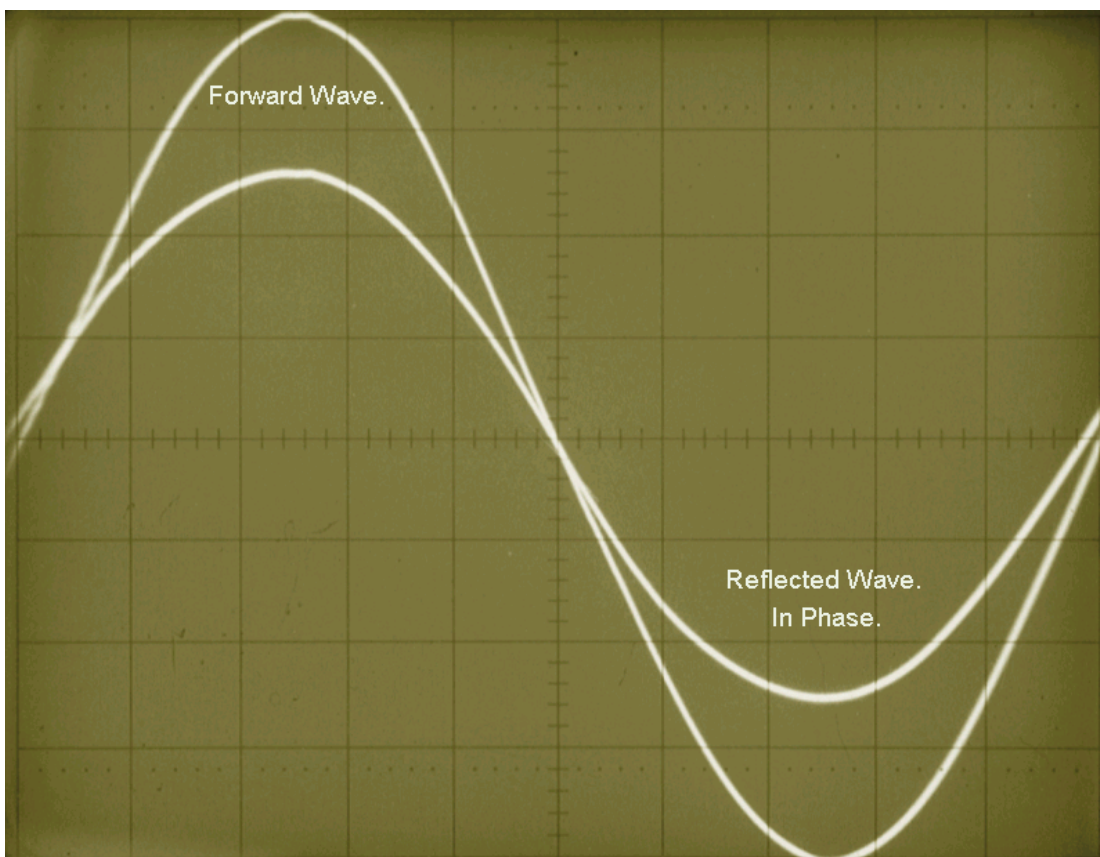

Figure 18. Using a reflection bridge, whenever our speaker load impedance exceeds the cable Z_0 or characteristic impedance at that frequency, a reflected wave, in phase with the forward signal is observed, except when a cable end C/R matching termination is used.

Results of the D. Self / Maplin mosfet amplifier, cable, load tests.

Initially using unterminated cables up to the voltage when RF bursts first become apparent, then complete each test, using the relevant C/R cable end termination while recording second and third harmonic distortions. Finally using this C/R termination network at the highest test voltage which is RF burst free, to ascertain any change in measured distortion, with/without this termination.

Self Amp.	8R2 Resistive Load - No Cable.				4R7 / 25µH Load - No Cable.			
	RF	2nd dB	3rd dB	C/R	RF	2nd dB	3rd dB	C/R
1v	No	-91.5	-91.0	None	No	-85.5	-91.0	None
2v	No	-90.0	-97.0	None	No	-83.0	-96.2	None
3v	No	-88.5	-100.0	None	No	-82.0	-98.2	None
4v	No	-87.5	-100.1	None	No	-81.6	-100.4	None
5v	No	-86.8	-103.0	None	No	-81.4	-101.4	None

Self Amp.	4R7 / 25µH Load - 4.9metre 79 Strand Cable.				4R7 / 25µH Load - 4.9metre Supra Cable.			
	RF	2nd dB	3rd dB	C/R	RF	2nd dB	3rd dB	C/R
1v	No	-85.4	-90.5	None	No	-85.6	-90.6	None
2v	No	-83.5	-96.2	None	No	-83.2	-96.1	None
3v	No	-82.4	-98.9	None	No	-82.3	-98.4	None
4v	No	-81.8	-100.7	None	No	-81.7	-100.4	None
5v	No	-81.5	-102.0	None	No	-81.4	-102.4	None
5v	No	-81.5	-102.0	Yes	No	-81.4	-102.3	Yes

Self Amp.	4R7 / 25µH Load - 4.9metre PTFE Cable.				4R7 / 25µH Load - 4.9metre #44 Cable.			
	RF	2nd dB	3rd dB	C/R	RF	2nd dB	3rd dB	C/R
1v	No	-85.7	-90.9	None	No	-85.6	-90.5	None
2v	No	-82.9	-95.7	None	No	-82.8	-95.5	None
3v	No	-82.2	-98.8	None	Yes	at 2.5v		None
4v	No	-81.8	-100.8	None				
5v	No	-81.6	-102.50	None				
5v	No	-81.5	-102.3	Yes				

Self Amp.	4R7 / 25µH Load - 4.9metre #44 Cable.				4R7 / 25µH Load - 4.9metre #55 Cable.			
	RF	2nd dB	3rd dB	C/R	RF	2nd dB	3rd dB	C/R
1v	No	-85.6	-90.5	None	No	-86.2	-90.9	None
2v	No	-82.8	-95.5	None	No	-83.7	-96.0	None
2.1v					Yes	-57.3	-64.7	None
3v	No	-81.9	-98.3	Yes	No	-82.3	-98.5	Yes
4v	No	-81.5	-100.3	Yes	No	-81.7	-100.4	Yes
5v	No	-81.2	-101.9	Yes	No	-81.6	-102.4	Yes

Self Amp.	4R7 / 54µH Load - 4.9metre PTFE Cable.				4R7 / 54µH Load - 4.9metre Supra Cable.			
	RF	2nd dB	3rd dB	C/R	RF	2nd dB	3rd dB	C/R
1v	No	-85.9	-91.2	None	No	-85.3	-91.1	None
2v	No	-83.5	-96.1	None	No	-83.9	-96.5	None
3v	No	-82.9	-99.1	None	No	-82.9	-99.2	None
4v	No	-82.7	-101.1	None	No	-82.4	-101.3	None
5v	No	-82.2	-102.7	None	No	-82.1	-103.0	None
5v	No	-82.2	-102.5	Yes	No	-82.0	-103.2	Yes

Self Amp.	4R7 / 54µH Load - 4.9metre #44 Cable.				4R7 / 54µH Load - 4.9metre #55 Cable.			
	RF	2nd dB	3rd dB	C/R	RF	2nd dB	3rd dB	C/R
1v	No	-85.3	-90.8	None	No	-85.5		None
2v	No	-83.8	-96.1	None	No	-83.6		None
2.1v	Yes				Yes			
3v	No	-82.9	-99.3	Yes	No	-82.6	-99.2	Yes
4v	No	-82.2	-100.5	Yes	No	-82.1	-100.2	Yes
5v	No	-82.2	-102.3	Yes	No	-81.9	-102.5	Yes

Self Amp.	4R7 / 110µH Load - 4.9metre PTFE Cable.				4R7 / 110µH Load - 4.9metre Supra Cable.			
	RF	2nd dB	3rd dB	C/R	RF	2nd dB	3rd dB	C/R
1v	No	-85.5	-90.9	None	No	-86.3	-90.8	None
2v	No	-83.6	-96.1	None	No	-84.1	-96.3	None
3v	No	-82.9	-98.6	None	No	-83.3	-98.9	None
4v	No	-82.6	-100.8	None	No	-82.6	-101.1	None
5v	No	-82.3	-102.5	None	No	-82.4	-102.8	None
5v	No	-82.4	-102.3	Yes	No	-82.1	-102.5	Yes

Self Amp.	4R7 / 110µH Load - 4.9metre #44 Cable.				4R7 / 110µH Load - 4.9metre #55 Cable.			
	RF	2nd dB	3rd dB	C/R	RF	2nd dB	3rd dB	C/R
1v	No	-86.4	-91.5	None	No	-87.3	-92.2	None
2v	No	-84	-96.5	None	No	-84.9	-97.1	None
2.2v	Yes			None	Yes			None
3v	No	-83.3	-100.1	Yes	No	-83.9	-100.1	Yes
4v	No	-82.5	-100.8	Yes	No	-81.4	-101.6	Yes
5v	No	-82.3	-102.8	Yes	No	-83.4	-103.4	Yes

Self Amp.	4R7 / 250µH Load - 4.9metre PTFE Cable.				4R7 / 250µH Load - 4.9metre Supra Cable.			
	RF	2nd dB	3rd dB	C/R	RF	2nd dB	3rd dB	C/R
1v	No	-86.7	-90.7	None	No	-86.5	-90.7	None
2v	No	-84.5	-95.6	None	No	-84.6	-96.3	None
3v	No	-83.6	-99.1	None	No	-83.4	-98.6	None
4v	No	-83.1	-100.8	None	No	-83.1	-101.0	None
5v	No	-82.9	-102.6	None	No	-82.9	-103.0	None

Self Amp.	4R7 / 250µH Load - 4.9metre #44 Cable.				4R7 / 250µH Load - 4.9metre #55 Cable.			
	RF	2nd dB	3rd dB	C/R	RF	2nd dB	3rd dB	C/R
1v	No	-87	-91.1	None	No	-87.1	-91.1	None
2v	No	-84.3	-96.6	None	No	-84.3	-96	None
2.25v	Yes			None	Yes			None
3v	No	-83.4	-99.2	Yes	No	-83.8	-98.8	Yes
4v	No	-83.2	-101.5	Yes	No	-83.2	-101.3	Yes
5v	No	-82.8	-102.9	Yes	No	-83.1	-102.8	Yes

With all these amplifier, cable and test load combinations, no measurable change of distortion with change of cable was found, provided the speaker end of the cable was terminated with the appropriate components needed to match the cable RF Z0 to prevent amplifier oscillations. However even the smallest RF oscillation resulted in clearly audible distortion.

Similar results were found using the Maplin amplifier with 4.9metre and 10metre cables and test loads, also when driving the ESP_replica assembly with either amplifier. When using 10metre cable lengths, the Maplin amplifier frequently oscillated as soon as the unterminated cable with load was attached even with no 1kHz input. Both amplifiers were completely stable with all my cables and the 8.2Ω resistive load so clearly these oscillations result from the cable speaker high frequency impedance mismatch reflections and not cable capacitance.

Testing with more and longer cables, RF oscillations were seen at frequencies slightly above and below 2.5MHz. Due to the effect of these amplifier Zobel and output inductors, the peak transfer of signals reflected from a 4.9metre cable back into the amplifier feedback point, occurred between 3.3MHz and 3.9MHz. With 10metre cables this peak frequency reduces to between 2.8MHz and 3.5MHz.

At higher and lower frequencies, reverse transfer through the amplifier Zobel and output inductors is substantially reduced, becoming less than 25% of this peak value, placing limits on those frequencies when sufficient reflected energy can pass back inside the amplifier. Above 3MHz even with no cable end terminations, due to cable transit times, speaker phase angle changes and reducing speaker impedances, reflected wave amplitudes reduce and with further increase in frequency, then may become out of phase

with the forward signal. Below 1MHz, much smaller amplitude reflections result, as shown by the reflection coefficient simulation plots in part 1.

These effects all combine to restrain RF oscillations to a relatively narrow band of frequencies, around 2.5 to 3MHz, with most cables, speaker loads and amplifier designs.

These cable and resonance tests can be summarised by listing those 4.9metres long unterminated cables which did not cause either amplifier to oscillate. Using the 100 Ω 79 Strand, 40 Ω Supra and my 30 Ω PTFE unterminated cables with both the Self and Maplin amplifiers with the ESP_replica assembly and all 4.7 Ω /inductor test loads at 1kHz, no oscillations were seen up to the amplifier's maximum current.

With unterminated 10metre lengths, all cables including the 79 Strand resulted in RF oscillations with one or both amplifiers and one or more test loads. Oscillation frequencies now ranged from a low of 1.85MHz for the 10metre #55 cable to a high of 3.8MHz for the 10metre 79 Strand cable. Clearly using a low impedance/high capacitance cable is not the dominant cause of these amplifier RF oscillations.

With the appropriate C/R termination connected at the test load or speaker terminals end of the cable, both amplifiers were completely stable when tested up to 25 watts with the ESP_replica assembly and to their rated current output into all the 4.7 Ω /inductor test loads and all my cables. Clearly these proposed cable end C/R terminations do work with practical amplifiers and loads, exactly as shown in the simulations. Eliminating in phase reflections from the cable far end load, provides a practical cure.

Recalling how just 3 volts amplifier output with a low impedance, unterminated cable, smoked my amplifier illustrates the benefit to be obtained using a simple C/R cable end terminator, but did this earlier instability result from the cable, amplifier or my choice of 25 μ H inductance ? Repeating these tests but now using 4.7 Ω with 54 μ H, then 111 μ H and finally 250 μ H produced near identical results.

Shorter cables ?

I concentrated on measuring 4.9 and 10metre cables because those lengths are most often used, however if you use a self-powered speaker system, cable length may then be only 1-2metres. Using lengths of 79 Strand also #55 cable, I measured large in phase reflections at 1MHz with 1 and 2metre unterminated lengths of both cables. Simulations then confirmed these reflections could result with all my cables with lengths up to 20metres. However much smaller and usually out of phase reflections were found using 100 Ω cables longer than 20metres.

These reflections measured using such short cables may surprise, but are completely in accord with transmission line theory which states reflections result from the impedance mismatch between cable and load termination, and except near 1/4 wave resonant frequencies, are not dependant of the cable's length.

Amplifier components ?

Looking carefully at the amplifier components used I wondered whether component changes might prove beneficial, especially the emitter resistors used in the D. Self bipolar amplifier. In his writing Douglas stressed these should be non-inductive, however the specified parts were wirewound. Removing one of these 0.22 Ω resistors from the failed amplifier for measurement, at 10MHz it measured 19 Ω for 0.3 μ H inductance. At 1MHz this inductance significantly increases the amplifier output impedance. I installed a pair of genuine low inductance power metal oxide resistors into my remaining D. Self amplifier, would this amplifier now need different terminations ?

Connected to my double length #55 cables, test load and no C/R termination and no generator input, this bipolar amplifier now oscillated rather worse than had my Maplin mosfet. Before I gained any usable test results the amplifier self destructed. Clear proof that design does need some inductance in it's emitter resistors. Now have destroyed three bi-polar amplifiers, leaving only my two Maplin mosfet amplifiers.

Re-examining my Maplin mosfet amplifiers, I wondered whether improved capacitors might help? Both these and the D. Self amplifier, had specified inadequate, metallised PET capacitors for the output Zobel networks. To sustain 25 watts output at 20kHz requires more capable, AC rated capacitors. Apart from the distortion implications using PET, we must also bear in mind that typical AC ratings for 100nF metallised PET capacitors will be specified for 1kHz and require substantial de-rating for higher frequency use. I had available some distortion tested, Siemens MKP 250 volt capacitors which would just fit in the available space for this output network and also for the supply rail decoupling capacitors. All low value small signal capacitors were changed to either Polystyrene or COG ceramic, the input 10 μ F electrolytic changed to a 10 μ F metallised Polysulphone film capacitor and finally the 47 μ F feedback polar electrolytic was replaced by a 50v bi-polar electrolytic capacitor.

These capacitor changes did produce some improvement. With the #55 cable and unterminated test load this amplifier now reached 2.4v for the first visible RF bursts, see figure 19, when previously it had only managed 1.83v. A notable improvement using these better components, but still needs our termination.

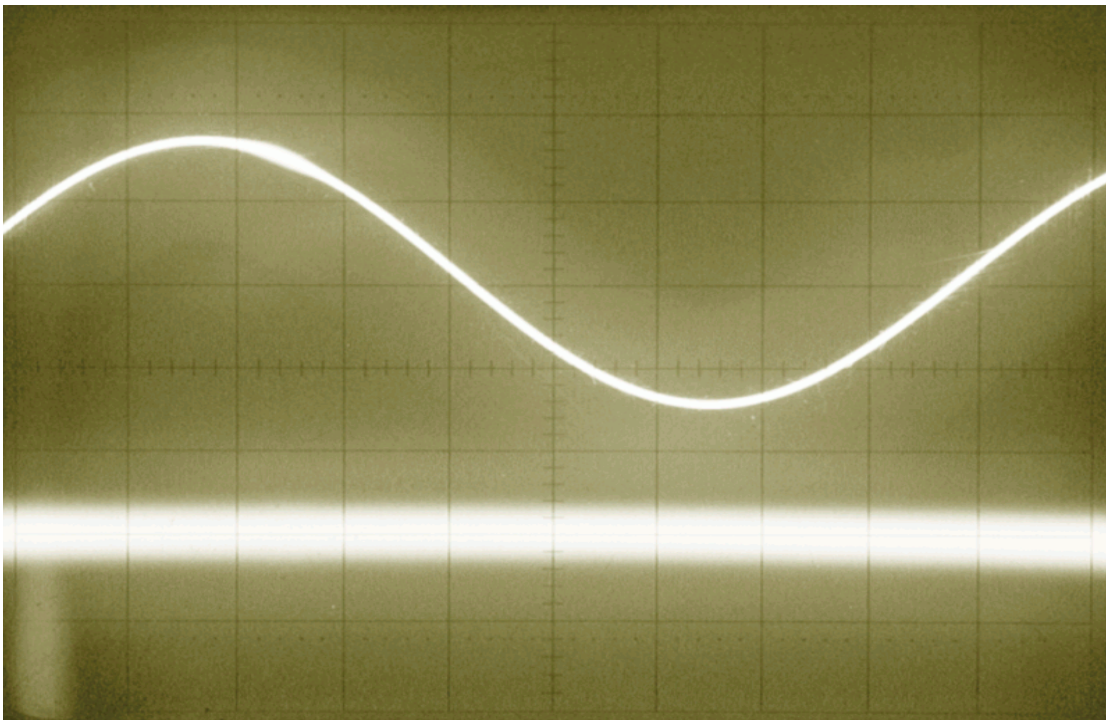

Figure 19. First visible RF oscillations using revised Maplin amplifier using selected capacitors at 2.4v drive. RF is just visible on the output waveform using ESP replica load, with unterminated #55 test cable.

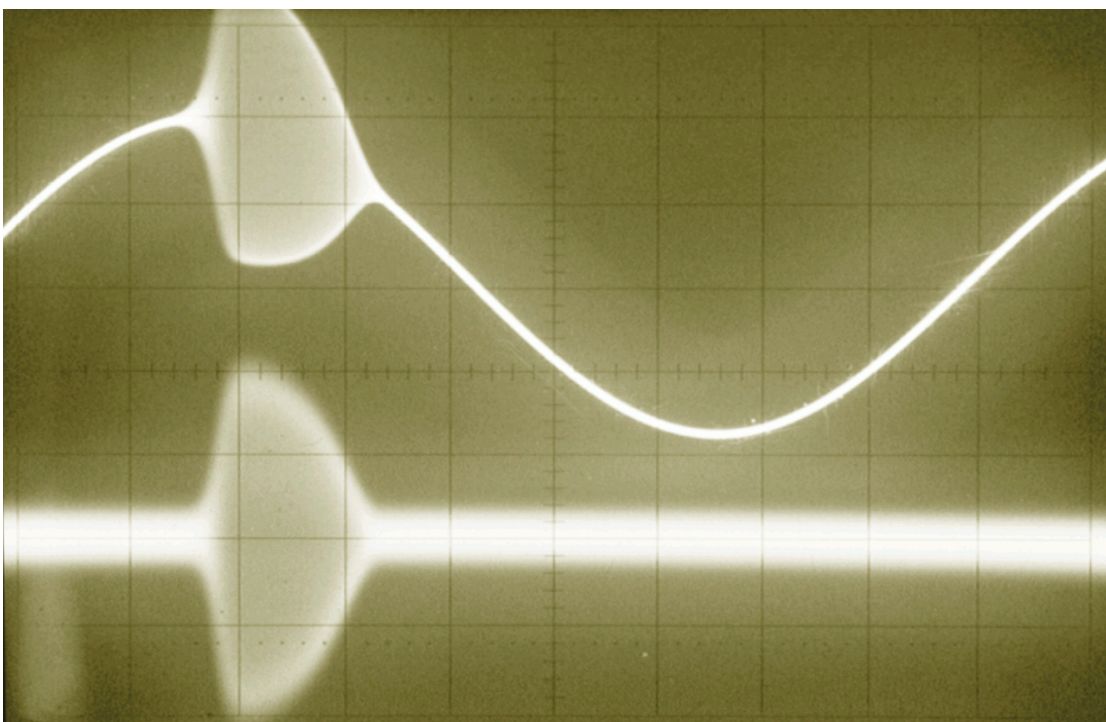

Figure 20. Increasing drive to 3v produced notably larger RF oscillations, using the same ESP replica load and unterminated #55 test cable. Distortion was clearly audible, but this test amplifier survived.

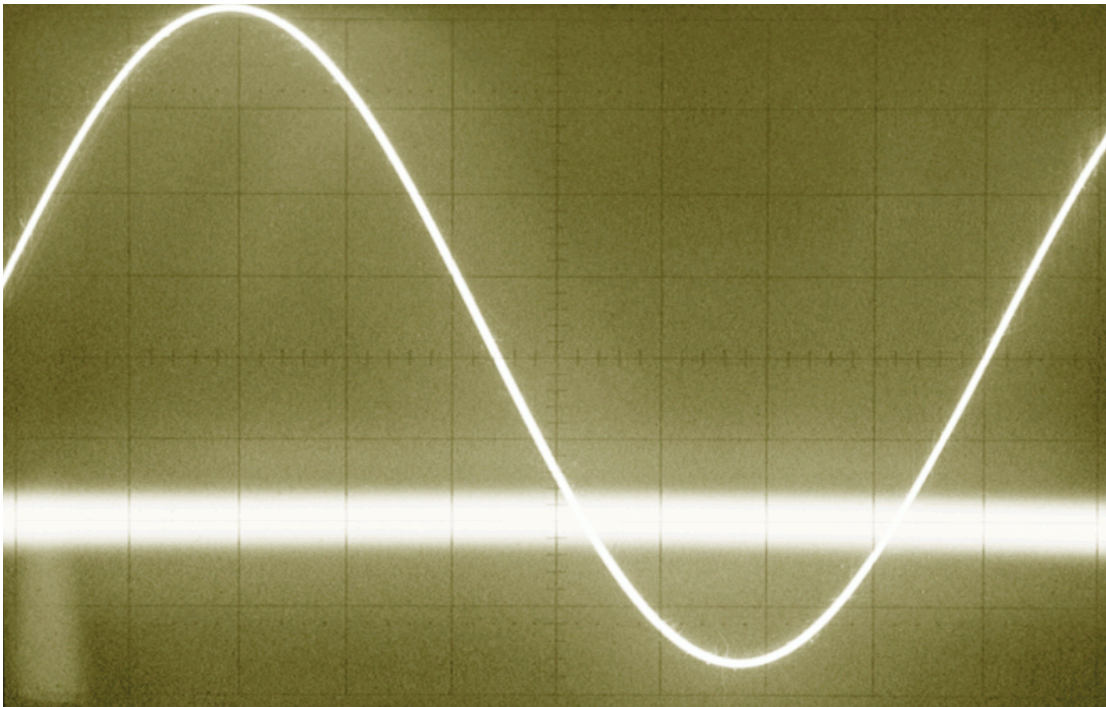

Figure 21. Simply by adding our 100Ω shunt resistor with a 33nF/15Ω C/R termination, this amplifier was driven to 6.2v as shown.

It remained perfectly stable even driven at its design maximum output current.

Cable-Load Reflections.

Finally, using the directional coupler, I measured reflections from my test cables driving into the ESP_replica speaker assembly, using both 4.9 and 10metre cable lengths. Initially with the cable end unterminated, then using the termination values shown in part 1 figures 14 through 17. With no C/R termination, reflections had large amplitudes, hardly smaller than the drive signal. Typically from 150kHz to 3MHz, the reflected wave was seen to be clearly in phase/same polarity as the drive signal.

To prevent amplifier RF oscillations resulting from cable and speaker mismatch reflections, we need to minimise all in phase reflections or try to ensure any remaining reflection is out of phase with the drive signal. At low and audible frequencies, when the cable impedance far exceeds that of the speaker load, speaker reflections cannot be reduced, but fortunately these reflections will always be out of phase with the drive signal. Repeating these reflection bridge measurements, but now using the cable speaker end, termination networks shown in part 1 figures 14 through 17, the reflected waves were visibly out of phase, typically from 150kHz up to 6MHz for 79 Strand, Supra and PTFE cables. Properly terminated, the reflections from the two lowest impedance cables, #44 and #55 remained out of phase up to 10MHz.

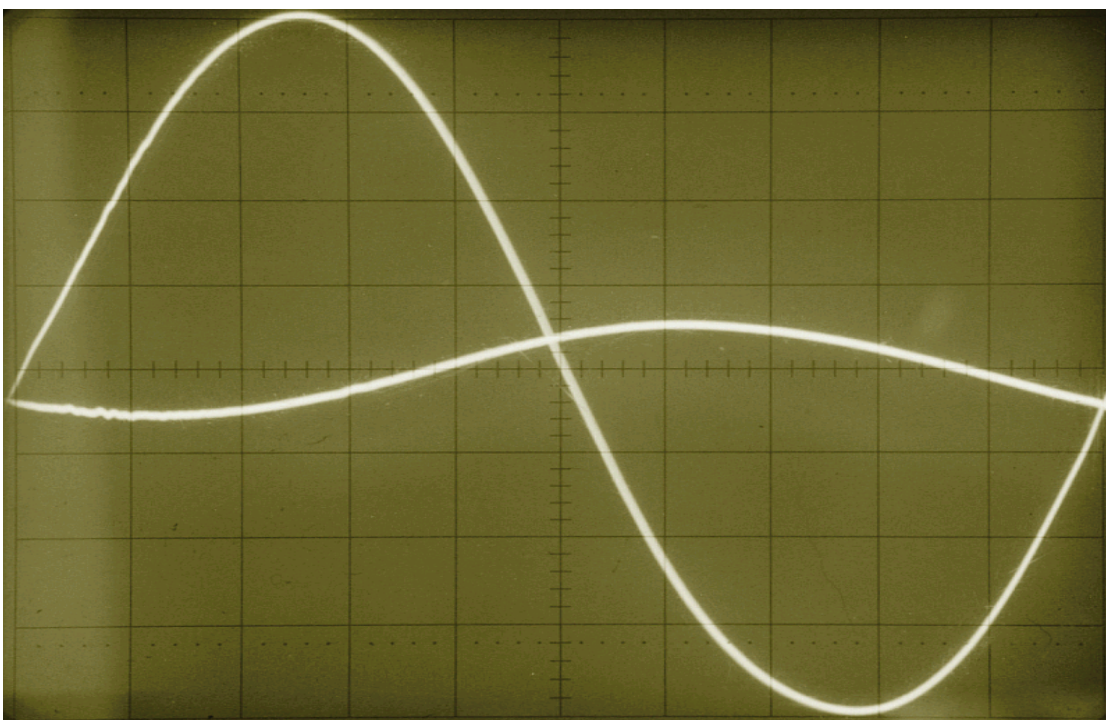

Figure 22. Measuring our ESP_replica speaker load, small time differences are seen between the forward and return signals, caused by the relative phase differences between our cable and speaker load impedance phases, at the test frequency.

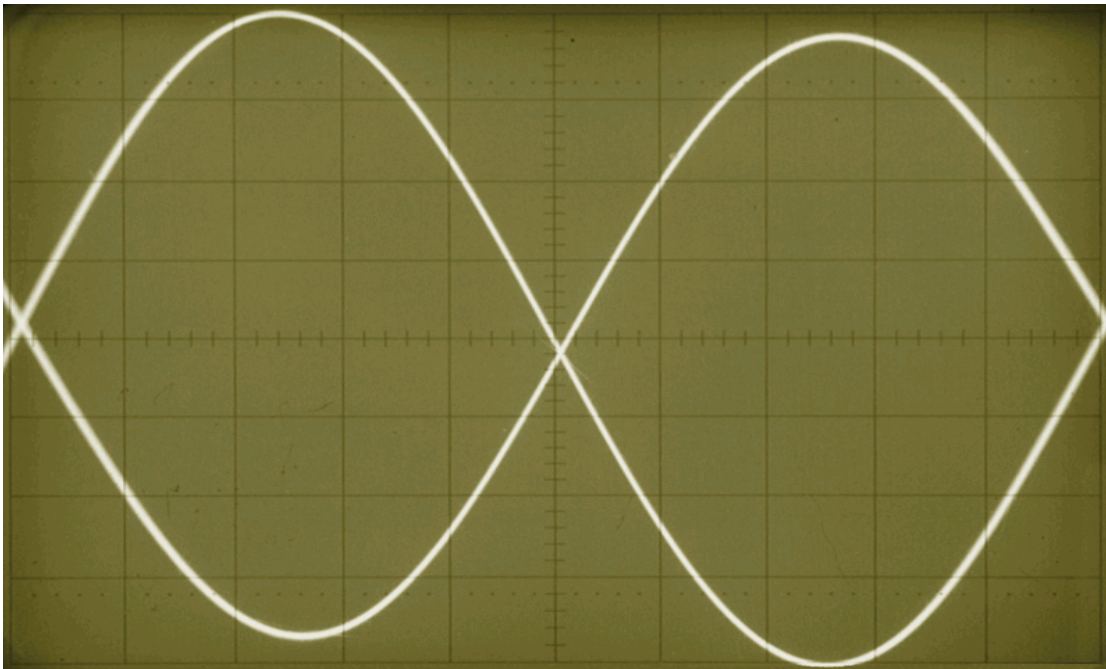

Figure 23.
Out of phase reflections at 10kHz, as measured at the amplifier terminals, from the ESP replica load, using 79 Strand cable.

Cable Z0 far exceeds the speaker impedance, so reflections can't be reduced.

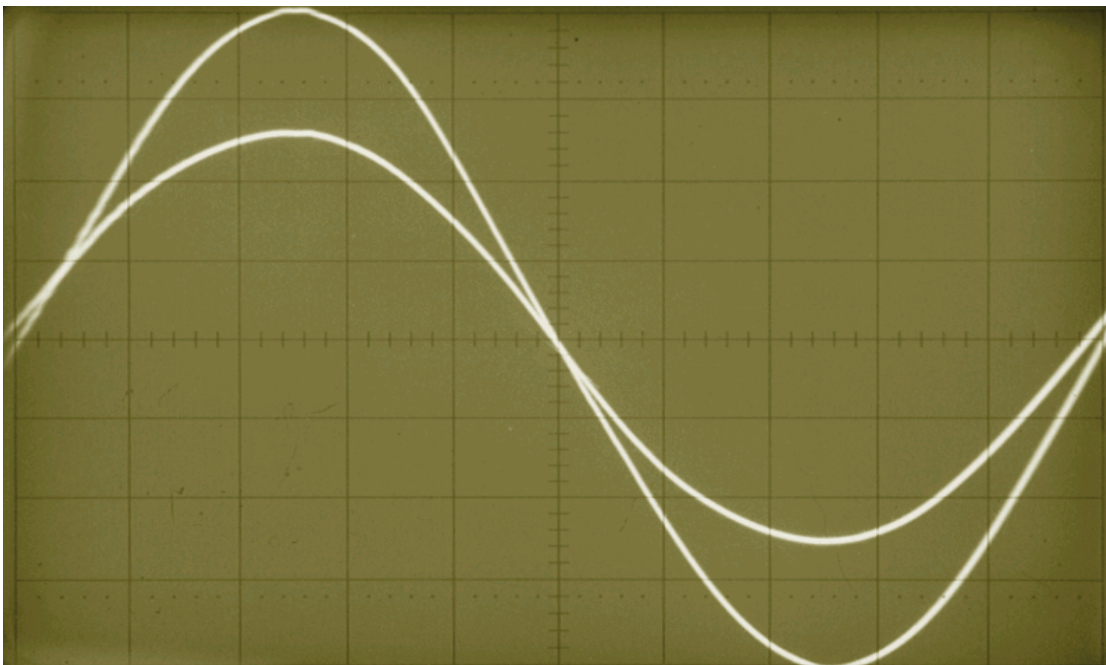

Figure 24.
In phase reflections at 1MHz measured at amplifier terminals from ESP_replica load, using unterminated 79 Strand cable.

A Reflection coefficient of 0.61

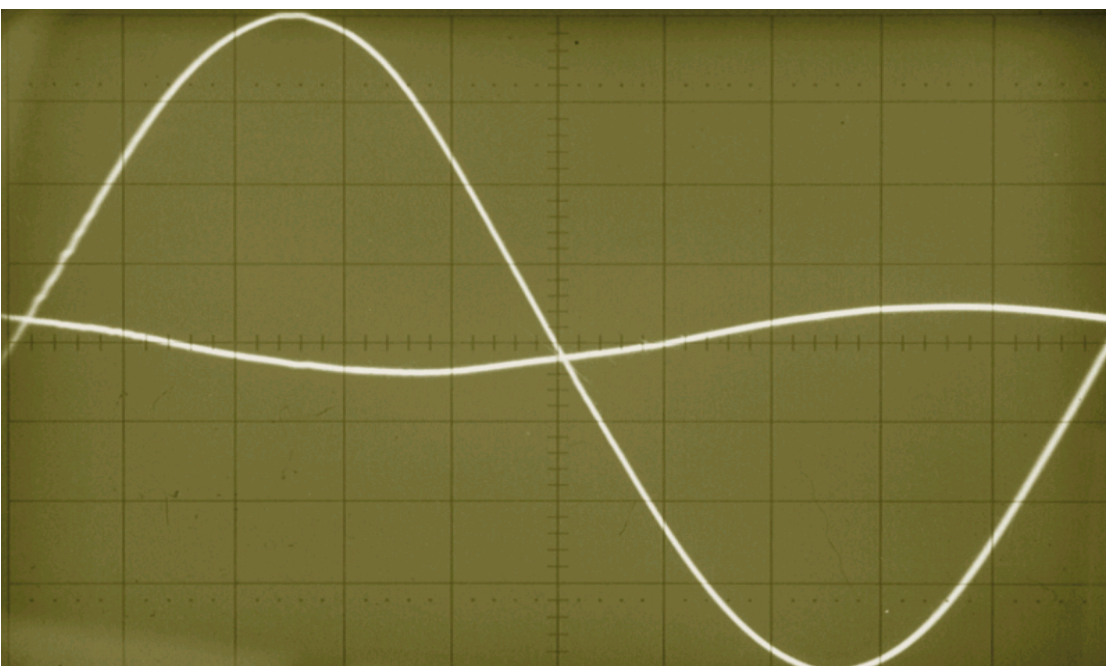

Figure 25.
Out of phase reflections at 1MHz at amplifier terminals from ESP replica load, when using C/R terminated 79 Strand cable.

Reflection coefficient now reduced to 0.098

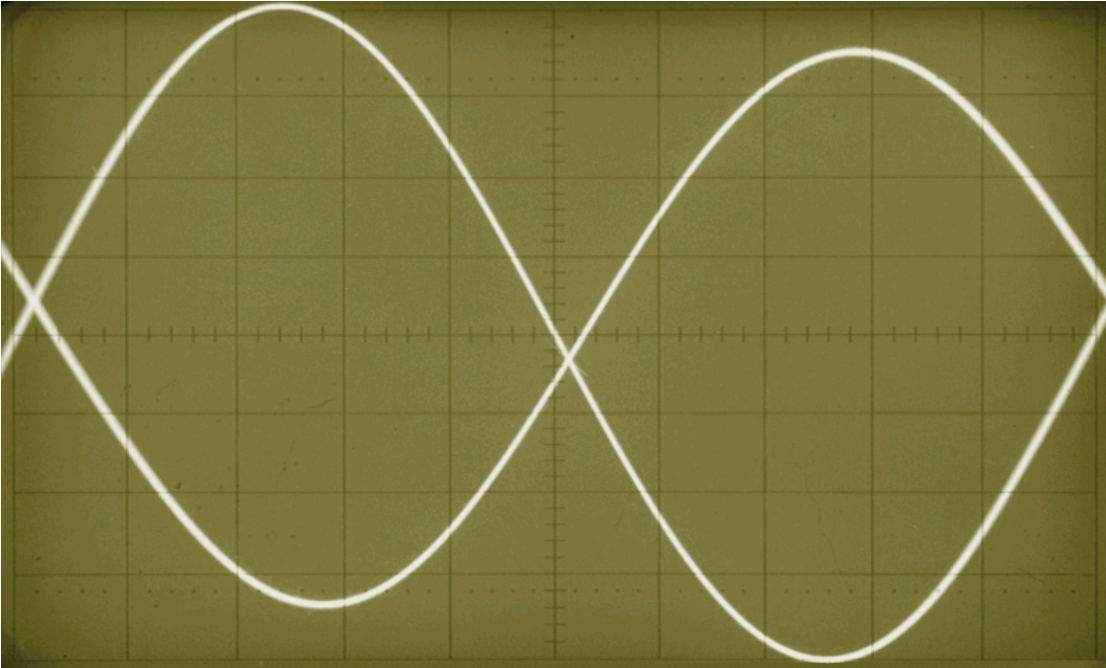

Figure 26.
Out of phase reflections at 10kHz measured at amplifier terminals from ESP replica load, using Supra test cable. This cable Z0 is lower than the 79 Strand, so reduces audio VSWR and reflections.

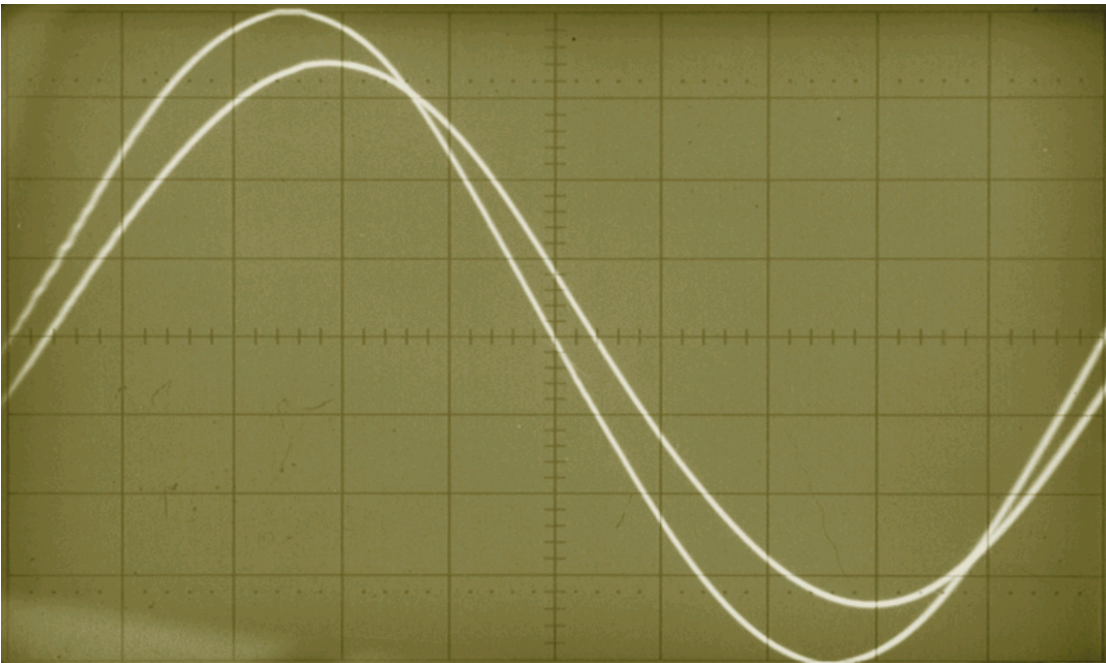

Figure 27.
In phase reflections at 1MHz measured at amplifier terminals from ESP replica load, using unterminated Supra cable.

However reflection coefficient now increases to 0.805

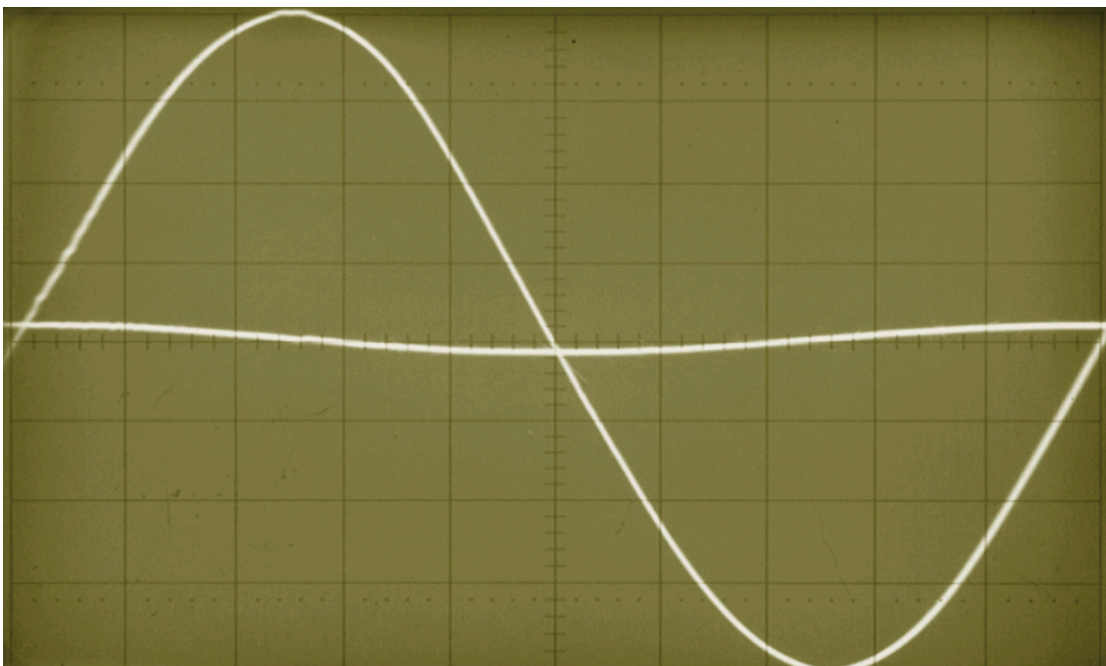

Figure 28.
Much reduced reflections at 1MHz measured at amplifier terminals from ESP replica load, when using C/R terminated Supra cable.

Reflection coefficient now reduced to 0.033

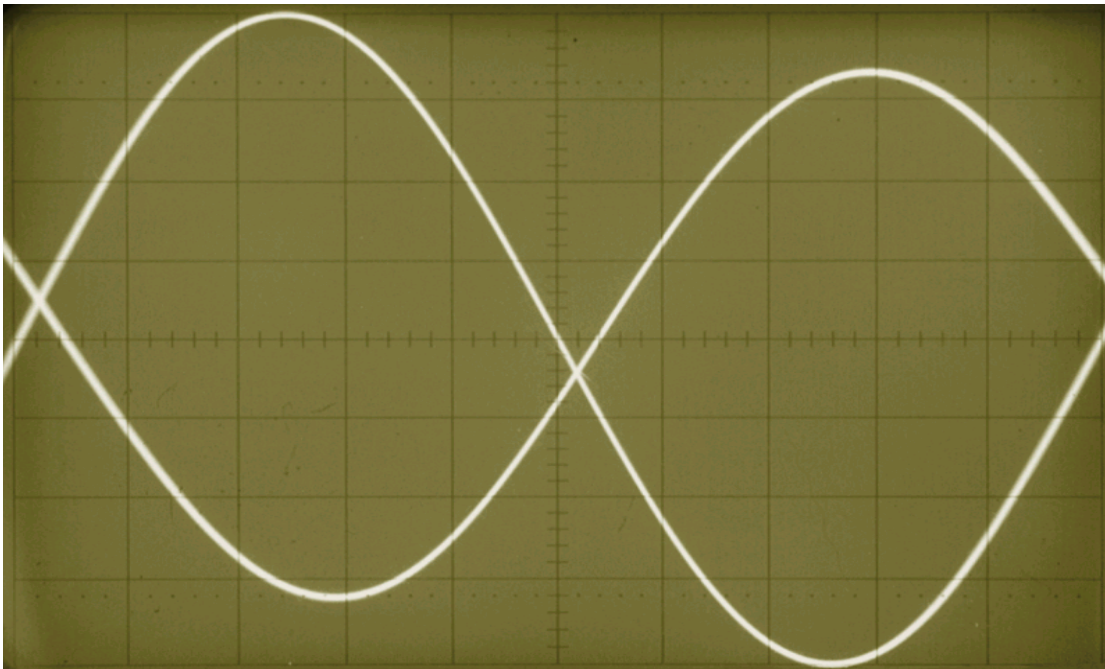

Figure 29. Out of phase reflections at amplifier terminals at 10kHz from ESP replica load, using PTFE test cable. Because this cable Z_0 is less than Supra, audio frequency reflections and VSWR again reduce.

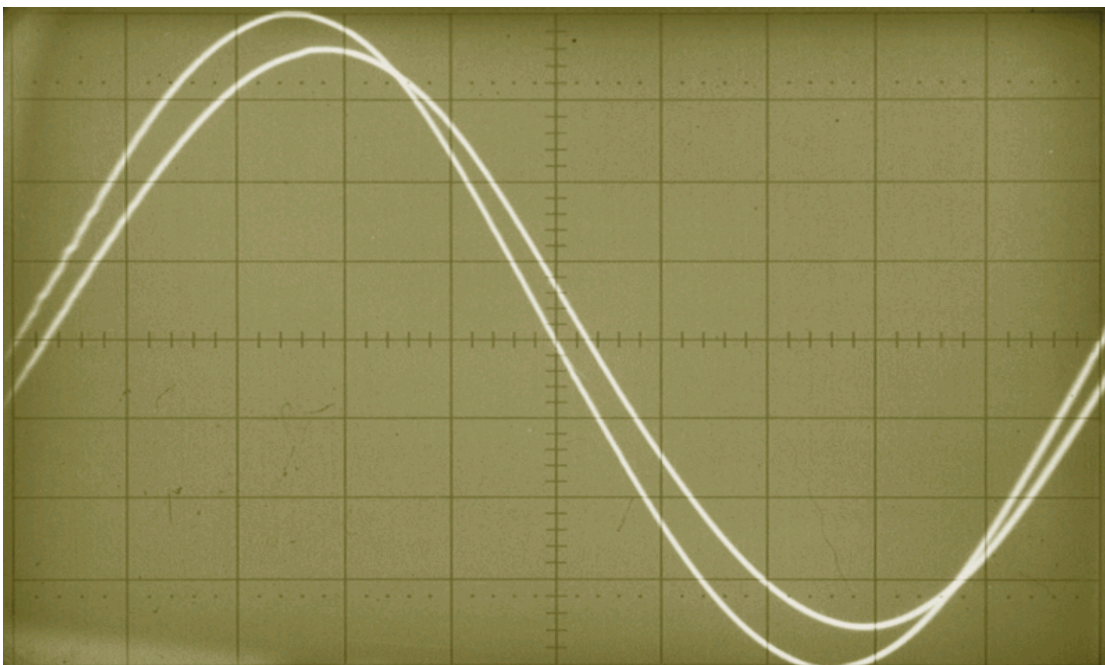

Figure 30. In phase reflections at 1MHz at amplifier terminals from ESP replica load, when using unterminated PTFE test cable. However reflection coefficient now increases even more to 0.87

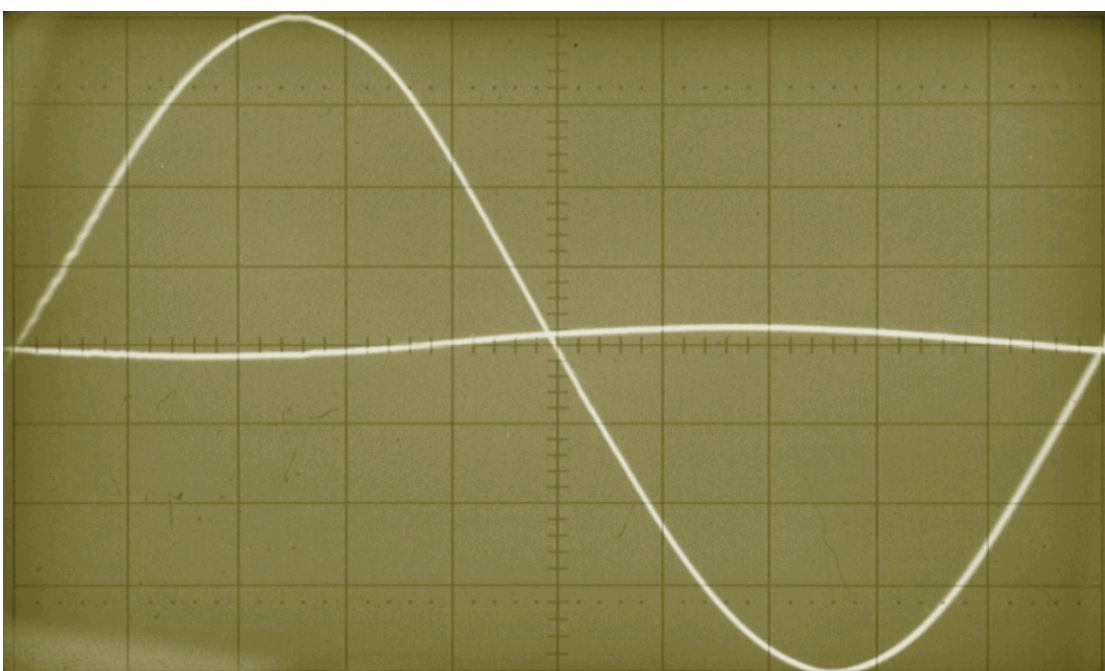

Figure 31. Out of phase reflections at 1MHz at amplifier terminals from ESP replica load, when using C/R terminated PTFE cable.

Reflection coefficient now improved to 0.045

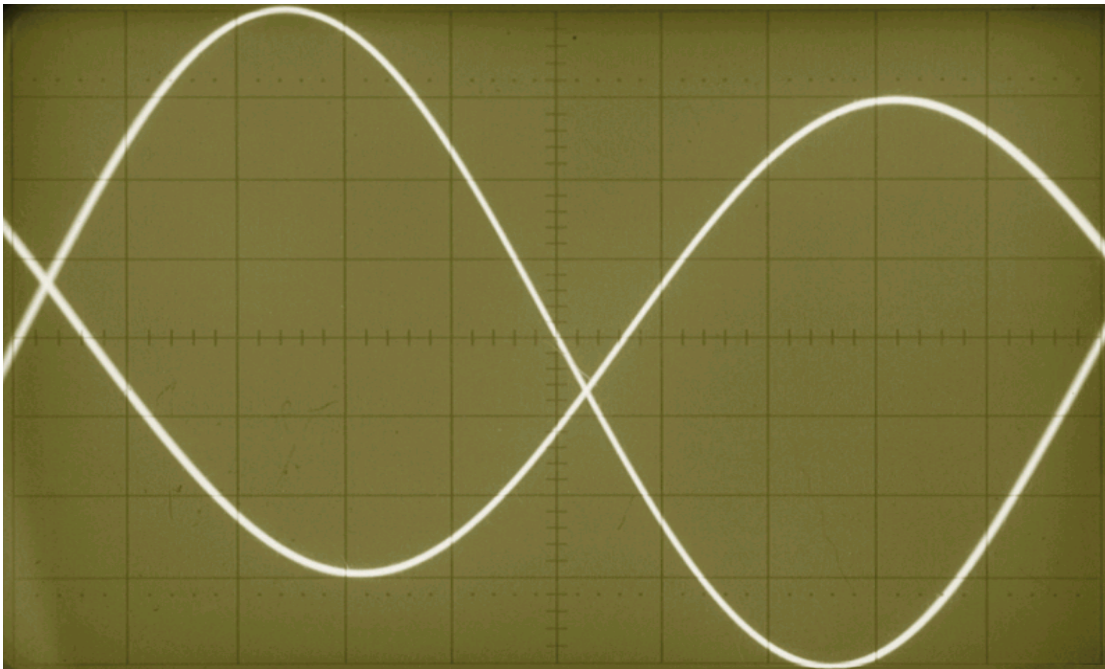

Figure 32.
Out of phase reflections at 10kHz at amplifier terminals from ESP replica load, when using #55 test cable.

Using #55 cable audio frequency 10kHz reflection coefficient reduces to 0.72

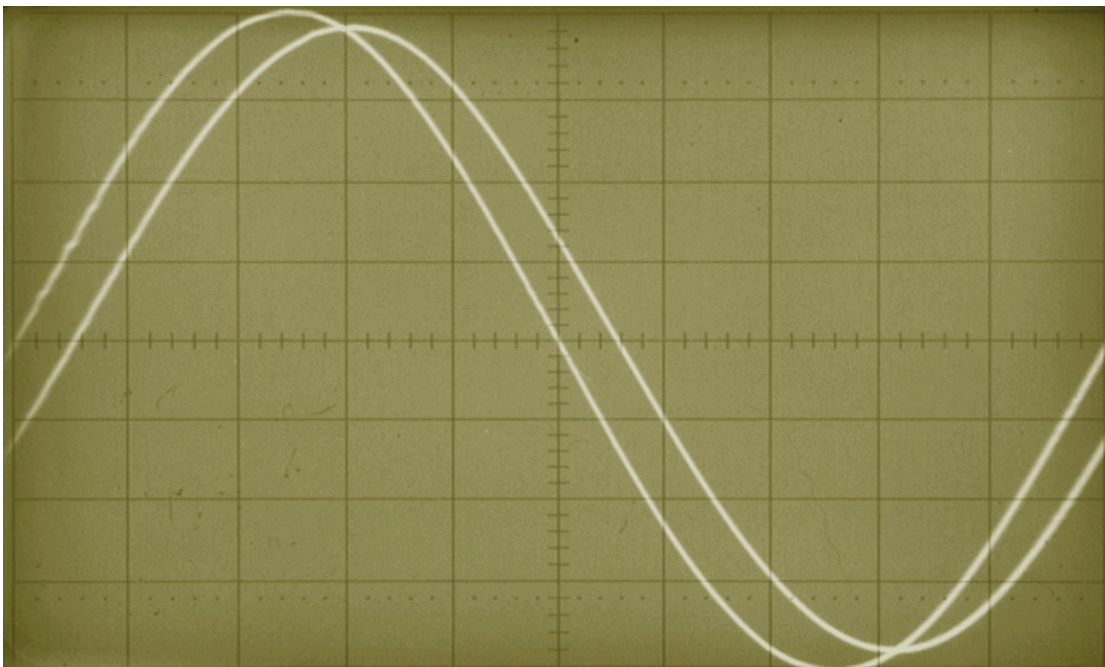

Figure 33.
In phase reflections at 1MHz at amplifier terminals from ESP replica load, when using unterminated #55 test cable.

Using #55 cable increases 1MHz reflection coefficient to 0.93

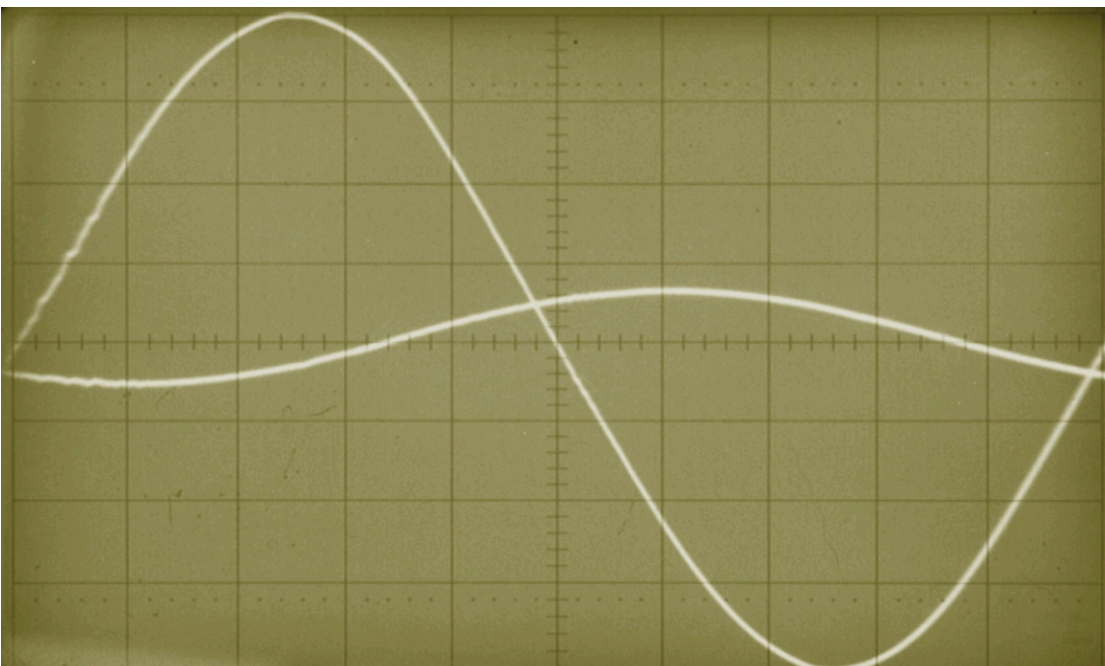

Figure 34.
Out of phase reflections at 1MHz at amplifier terminals from ESP replica load, when using C/R terminated #55 test cable.

Terminated reflection coefficient at 1MHz now 0.13

Since both the D. Self and Maplin amplifiers did include the conventional Zobel C/R and output inductor networks, how could these in phase reflections produced when using an unterminated cable with a high frequency, reactive, high impedance speaker load, be allowed to enter inside the amplifier. ?

Zobel RF attenuation.

To measure the Zobel and output inductor networks ability to attenuate RF appearing at the amplifier output terminals I connected my test loads using unterminated cables. With the amplifier un-powered I applied a signal to these test loads and measured the voltages appearing at the amplifier output terminals and at the amplifier internal feedback takeoff point. I swept frequency from audio to 1MHz observing both voltages using a two channel oscilloscope. At 1MHz and above both voltages were accurately measured using my two channel Hewlett Packard HP8405 vector voltmeter, using its pair of 100k Ω 2pF test probes, to determine the Zobel and output inductor attenuation.

In normal use, the speaker network or reactive test load presents a high impedance to the cable far end, so cannot be stimulated using my 50 Ω signal generator connected in parallel with the load. Injecting a current into the earthy end of the reactive test load worked well, allowing both load and cable end impedances to mimic being driven to 3 volts by the amplifier.

D. Self amplifier.

With the Supra cable and ESP_replica assembly, RF signals at the D. Self amplifier terminals were typically reduced to half at the feedback takeoff point. Amplifier terminal voltage varied with frequency, reaching a peak at 4.14MHz with 1.8v appearing at the terminals and 0.88v at the feedback takeoff point, reducing to a minimum around 1.5MHz, with 0.28v at the terminals, again almost halved to 0.15v at the feedback takeoff point. At 2.5MHz, with 0.75v at the amplifier terminals I measured 0.42v at the feedback takeoff point. Similar values were measured using the #55 cable.

To confirm these attenuations, I also measured the impedance of the Self amplifier at 2.5MHz, looking inwards from its output terminals to ground, it measured 20 Ω . Across the Zobel C/R to earth measured 10.5 Ω , confirming my measured values.

The Self bi-polar amplifier includes a speed up or phase advance feedback network, 100pF in series with 330 Ω , both in parallel with the 10k feedback resistor, resulting in this 0.42v being attenuated rather less than anticipated, to measure 0.16v at the base of the feedback transistor of the differential input pair.

This Self design also uses two 0.22 Ω 3watt wirewound emitter resistors, which have 0.3 μ H of self inductance, measuring 113 Ω at 50MHz, 19 Ω at 10MHz and 6.3 Ω at 3MHz, so while its output impedance at audio frequencies might be quite low, at 2.5MHz it must be many times larger, contributing to the poor RF attenuation of the output Zobel and inductor circuits.

Maplin mosfet amplifier.

The Maplin mosfet amplifier Zobel and output inductor produced rather better results. At 2.5MHz with 0.8v at the amplifier terminals, I measured 0.27v at the feedback takeoff point, because the Maplin C/R Zobel uses 4.7 Ω while the Self uses 10 Ω . The Maplin also does not have a phase advance network bypassing its feedback resistor so the voltage measured at the feedback point is reduced rather more, now measuring 0.014v at the feedback base junction of the differential input pair. This Maplin amplifier with much faster output devices and no emitter resistors has considerably more gain at 2.5MHz than the Self amplifier with its relatively slow bi-polar transistors and inductive emitter resistors.

Used with typical speaker loads and unterminated cables, both amplifier's Zobel networks and output inductors clearly do allow sufficient RF in phase signal reflections to pass from the amplifier output terminals right back to the base of the feedback transistor of the input differential pair, even at reasonably quiet, normal listening drive voltages.

Two quite inexpensive resistors, one directly across the speaker terminals, the second in series with a capacitor, across these terminals and having appropriate values for the cables used, effectively prevents unwanted high frequency oscillations, reducing potential amplifier damage, without affecting sound quality or distortion.

C/R networks used.

For figures 14 through 17 I used C/R networks matching the high frequency characteristic impedance of the speaker cable, which was already known because I measured the open circuit and short circuit terminated impedance of each cable at four frequencies, 1kHz, 10kHz, 100kHz and 2MHz, prior to starting any tests. High frequency characteristic impedance is easily calculated from these 2MHz values:-

$$Z_0 = \sqrt{Z_{open} \times Z_{short}}$$

however should you not be able to measure impedances at 2MHz acceptable results using low loss

cables, can be calculated from capacitance and inductance values, using the approximation $Z_0 = \sqrt{\frac{L}{C}}$.

For the 100Ω 79 Strand cable, figures 15, 25 I used only a simple C/R across the speaker terminals, a 10nF capacitor in series with a 100Ω 1 watt film resistor.

With the Supra 40Ω impedance cable, figures 16, 28 I used a 5 watt non-inductive 100Ω resistor across the speaker terminals in parallel with a C/R network comprising an 18nF capacitor in series with a 68Ω 1 watt film resistor.

For the 30Ω impedance PTFE cable, figures 17, 31 I again used the 5 watt non-inductive 100Ω resistor across the speaker terminals in parallel with a C/R network of an 18nF capacitor in series with a 42Ω 1 watt film resistor.

For the #55 low impedance 14Ω cable, figures 14, 34 I used the 5 watt non-inductive 100Ω resistor across the speaker terminals in parallel with a C/R network, but this time using a larger value capacitor of 33nF in series with a 15Ω 1 watt film resistor.

For my simulations I assumed a typical self inductance of 100nH for the 100Ω resistor, which should easily be attained using the Farnell resistor p.n. 551-594, alternately a parallel array of five 1 watt metal film resistors could also be used.

For the C/R series networks I used 20nH self inductance, assuming the use of conventional 1-2 watt metal film resistors with small plastic cased AC rated metallised polypropylene capacitors and short leadwires. For example the low cost BC Components 222-338-6 range, is Y2 approved and known to be very low distortion capacitors. Self inductance of 1cm straight 0.6mm leadwires approximates 7.5nH.

The above capacitance values were chosen to provide a consistent impedance when used with the above resistance values above 500kHz, the frequency when speaker impedances rapidly increase, without degrading system impedances at the highest audible frequencies. However it is advised you use only capacitors which can sustain the maximum anticipated AC voltage at the maximum work frequency and which are of known low distortion types.

ref.1 Capacitor Sound, C. Bateman Electronics World July 02, September 02 thru January 03.

Source of RF pickup ?

One final question now remains, what if anything may initiate these RF oscillations inside an amplifier, connected to an unterminated speaker cable and high frequency resonant speaker system ?

In 1997 when I suffered my Acoustic Research amplifier failure while driving a low impedance cable and my horn loaded speakers, I ran tests looking for a possible explanation. The published speaker

impedance curves indicated increased impedance at high audible frequencies. Because of the crossover inductors used, I speculated that impedance would continue to rise up to very high frequencies.

As part of those investigations I noticed a low level non-harmonic “noise” trace on my oscilloscope while monitoring the scope output of my HP331A distortion meter, attached to the amplifier output with cable and speaker connected. Subsequent measurements indicated an amplitude modulated signal which could be “synched” to the trace at 1 μ sec/cm, or approximately 1MHz, having an amplitude of 20mV, with the amplifier powered but not driven, connected using 100 Ω cable to my horn loaded speakers.

We never listen to AM radio broadcasts, so initially this signal was not recognised, but after talking to a BBC radio engineer, discovered we lived a few miles from two transmitters, one of 18kW on 1053kHz and estimated field strength of 100mV/m, the other 10kW on 693kHz with a 40mV/m field strength.

The BBC has many much more powerful transmitters, but all are located some distance away, the 198kHz Droitwich 500kW transmitter and Brookmans Park with 1089kHz at 400kW the most powerful, but due to distance both produce lower field strength at my location. My tuner’s signal strength meter indicated the “Talk Talk” transmission on 1053kHz produced the strongest signal of all, closely followed by an unknown “foreign” transmitter on 1395kHz then “Radio Five” on 693kHz. Many weaker signals were found above and below 1MHz.

The medium wave broadcast band covers from 526.5 to 1606.5kHz and long wave from 148.8 to 283.5kHz. Most AM transmitters are lower power, 10kW or less but the BBC “Radio Transmitting Stations” booklet listed 16 with power up to 50kW and 14 with much higher power. To minimise broadcast signal pickup on our speaker systems we need to minimise cable / speaker impedance over the MW and preferably also the LW AM bands, especially so if located closer to Droitwich or the 60kHz MSF time code transmitter at Anthorn in Cumbria.

We do have high power TV bands 1 and 3 also FM radio transmitters some twenty miles away but I have not found any RF pickup on my speaker systems at those frequencies.

To add to this RF noise problem, most homes now have broadband internet access. That also provides a source of RF at similar frequencies to AM radio, however in my case at the times when I broke all three amplifiers I only had a dial-up internet connection and no broadband.

Measuring my speaker system, I found impedances many times larger than expected especially near 1MHz, so wondered whether my high impedance cables and resonant speaker system crossover might be acting as an inefficient aerial. Replacing the 100 Ω twin line speaker cable with the low impedance #55 unterminated co-axial cable notably reduced, this signal pickup at the amplifier terminals.

In 1997, I decided for future protection against amplifier failure, I should attach a C/R network across my speaker cabinet terminals, to reduce my speaker’s high frequency impedance. The values I then used were chosen empirically, simply by trial and error while watching my scope trace. At that time my available test equipment did not permit today’s more detailed analysis.

Retested today and using the C/R terminations described in part 2, I find RF pickup at my amplifier terminals has been eliminated. No amplifier failures have occurred using C/R terminated cables.

This work has shown how RF reflections from unterminated speaker cables can result in audible distortions and previously unexplained amplifier failures.

As figures 23 through 34 also illustrate, speaker cables are not simply two wires, but within the power bandwidths of modern amplifiers, do comply fully with long established transmission line behaviour.

Conclusions.

My test amplifiers included the conventional C/R Zobel network and output inductor, but so far these have not been included in my simulation figures. The action of these networks at audible frequencies is well documented, but just what effect have these components, at high frequency ?

These final two simulations illustrate how the impedance of the ESP_replica speaker driven via 4.9metres of my #55 cable, changes with and without the proposed terminating C/R networks, measured at the cable end and as at the amplifier feedback point, using the Zobel components taken from a D. Self amplifier. Accuracy of these simulations has been confirmed by impedance and phase angle measurements, using my HP4815A vector impedance meter.

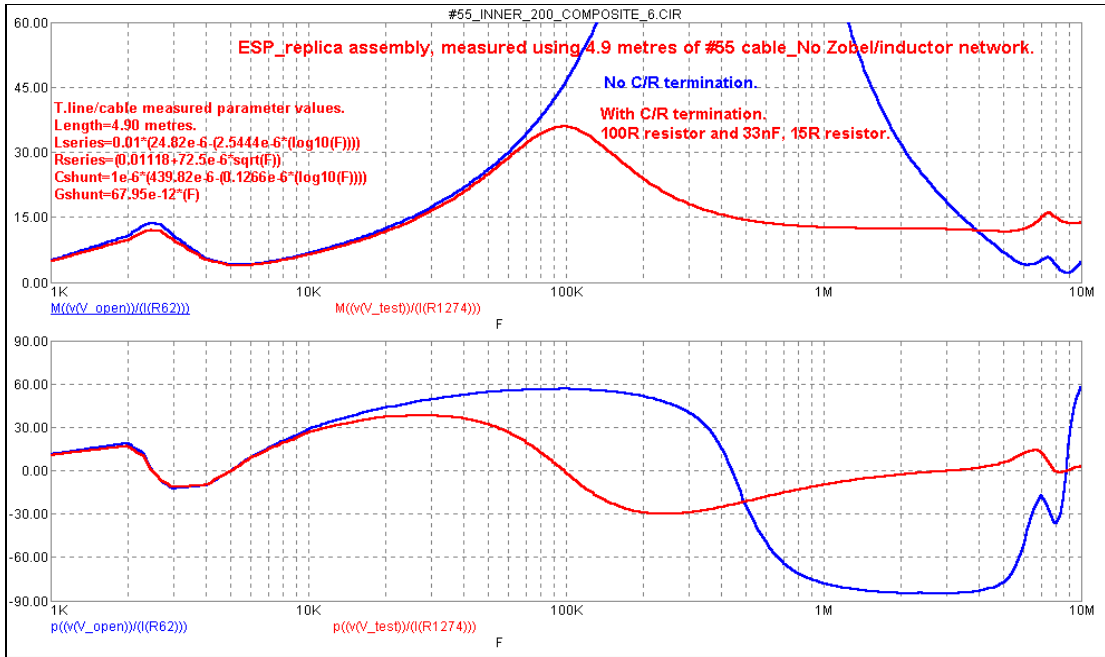

Figure 35. Illustrates the affect a termination network of 100Ω in parallel with 33nF and 15Ω, has on the ESP_replica speaker system when measured at the cable input end, no amplifier Zobel/inductor.

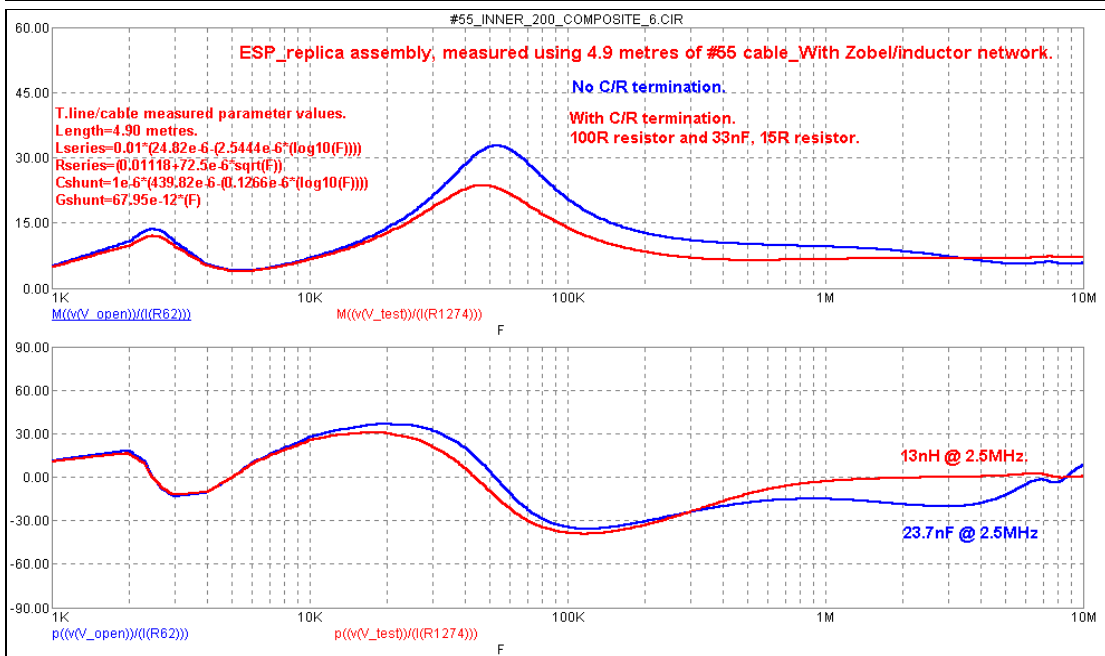

Figure 36. Shows the amplifier load impedance at the feedback point, using a termination network on the ESP_replica speaker system and #55 cable, when driven via the Zobel/inductor C/R circuits.

In addition to removing “In phase” cable reflections, the terminating network dramatically reduces the speaker/cable impedance and phase angles above 100kHz. Including our amplifier’s Zobel output network, the ESP_replica’s high impedance resonant peak, has been replaced by a near constant high frequency impedance, without impacting on impedance at audio frequency. Using this C/R termination the original system’s violent phase changes are replaced by a near constant phase angle, near resistive, high frequency load, more in line with the amplifier designers notional 8Ω resistive load. While 23.7nF at 2.5MHz may seem unimportant, it’s impedance is equivalent to a 59.25μF capacitive load at 1kHz.

Appendix 2. Reflection Bridge or Coupler.

For measurements at RF, a variety of reflection bridge/coupler designs are used. For modest frequencies, 1MHz to 100MHz, a reflection bridge based on three precision resistors and a toroidal Balun transformer is common. I have a pair of the Hewlett Packard 8721A reflection bridges, used as references. This design works well for 50Ω measurement systems but is not easily switchable for other impedances.

One reflection bridge design which can be switched to different cable impedances and is easier to build, replacing the Balun transformer by two op-amps, titled “Build a Vector Network Analyser” by Steve Dunbar was published in Electronic Design in “Ideas for Design” May 29, 2000. However like all reflection bridges it absorbs at least 6dB, so substantially attenuates the test signal.

At frequencies above 100MHz it is usual to use a directional coupler, usually based on two or three coupled transmission lines over a common ground, perhaps the best known example is the Hewlett Packard 778D which I used as a measurement reference for many years, it is specified for use from 100MHz to 2GHz. Such 90° couplers are usually designed to be electrically one quarter wavelength long at the lowest measurement frequency and to provide forward return directivity better than 40dB.

We can approximate a two line coupler by simply using some braidwire to overscreen a 4.9metre length of two wire speaker cable, using this screen as the common ground, the two cable cores, one to carry the signal the other to monitor reflections. For an experiment I overscreened a length of the Supra cable, which worked well at 50kHz and above to monitor cable far end reflections from my test loads.

A two transformer, directional coupler is often used for RF measurements instead of the 50Ω reflection bridge, because while it also separates out the forward and return signals in the cable, it absorbs almost no power, permitting forward and reflection measurements at much higher power levels. This ability to measure at relatively high power levels makes a directional coupler the preferred choice of many radio Hams wanting to optimise their antenna systems. An added attraction for our use, it's measurement reference impedance is easily changed by simply switching two resistance values.

For these reflection measurements, I assembled a version using two 10,000μ, high permeability toroids, winding a 31 turn secondary on each core, the primary being a single turn used to mount each toroid, see figs 37, 38. Using a two gang switch I was able to select 15, 25, 30, 39, 50, 62, 75 and 100Ω measurement impedances. At higher frequency, easily wound small, low permeability toroids are used but to measure down to audio frequency, high inductance, ensuring a secondary impedance many times larger than the desired measurement impedance, requires the use of large high permeability toroids.

Unlike a bridge, a directional coupler made using a pair of matching transformers needs no routine calibration and can be made to measure accurately over rather more than two decades of frequency. By simply changing the value of its two resistors, a dual transformer coupler can easily be adapted to measure at any desired cable impedance, using a multiway, two gang switch. For best accuracy measuring speaker reflections, the value of these terminating resistors should match our speaker cable's actual characteristic impedance at that test frequency. However, due to the extreme mismatches between speaker system and loudspeaker cable, if required we can relax this resistor/cable impedance matching, up to say a 1.2:1 impedance mismatch, in order to allow a practical low frequency sweep.

My initial attempts at devising a directional coupler usable down to 1kHz failed, because the impedance of the 10 turn secondary of the voltage transformer winding I used, loaded the line at low frequencies. Rewinding new transformers using a 31 turns secondary on much larger 10,000μ ferrite toroid cores, the winding inductance now exceeded 22mH. With a single turn primary winding this coupler works well from 5kHz to 5MHz using 50Ω termination, producing 30dB measurement isolation and reflection values identical to those measured using my Hewlett Packard 8721A 50Ω reflection bridges.

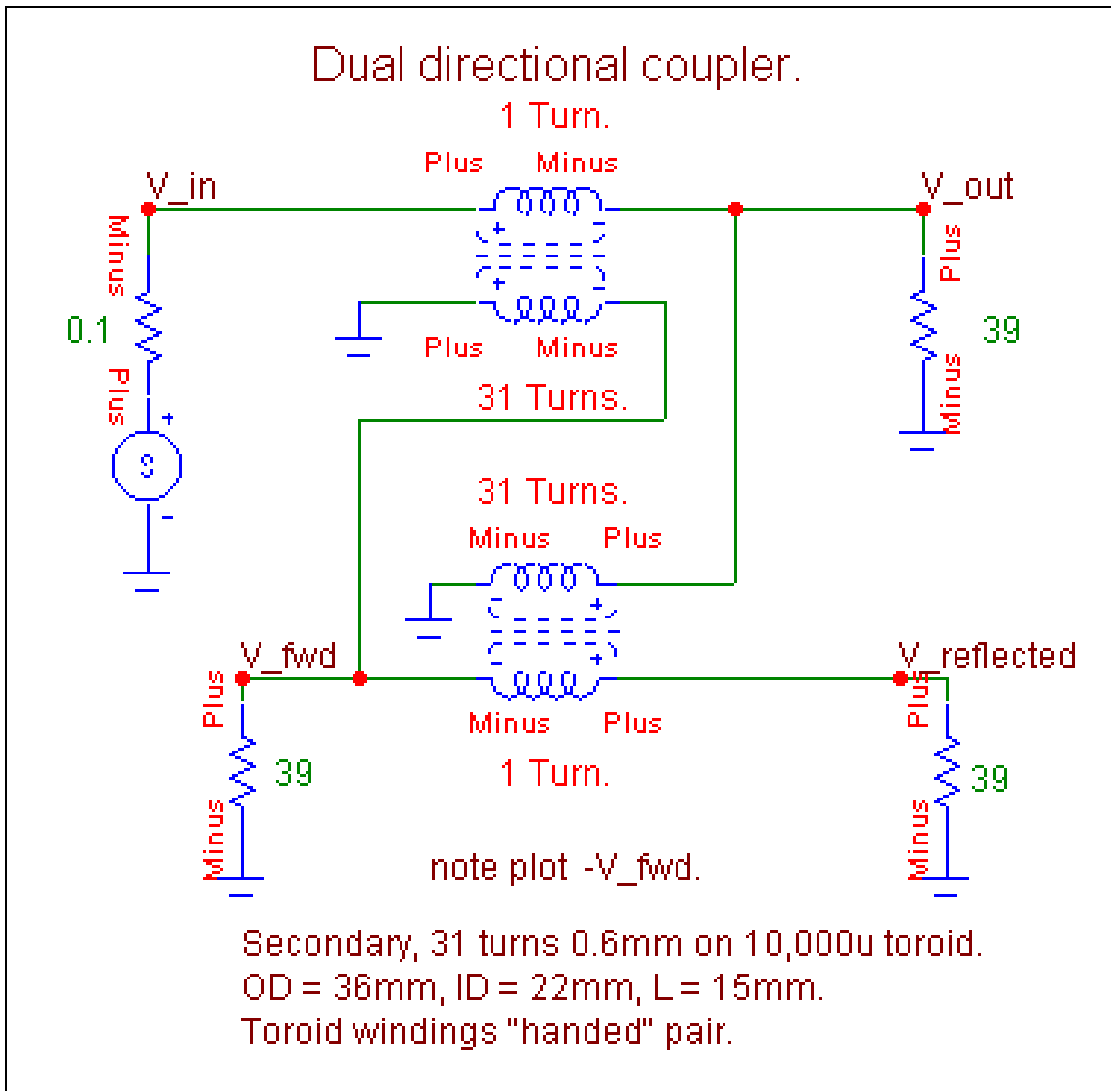

Figure 37. For low frequency measurements, a directional coupler can be built with two transformers, one to monitor current in the cable, the second the voltage waveforms. Correctly phased, these transformers separate out any forward and reflected signals present in the cable.

In use the speaker cable is connected to the "V-out" port.

Toroid core size used was 36mm OD, 22mm ID and 15mm long, with 31 turns. With low impedance cables, this coupler can be used down to 3kHz measurements.

Phased as shown in the photo, with a pair of "handed" transformer secondary windings, the reflected signal is correctly presented. The forward signal polarity however is reversed, so the relevant oscilloscope channel should be inverted, to view the correct forward waveform polarity. For RF measurements two identical couplers would usually be used back to back, extracting the forward signal only from one coupler, the reflected signal from the second to ensure the correct phasing when using RF meters. It is however much easier to build just one coupler and invert one oscilloscope channel.

With three precision 50Ω BNC terminations, directivity of the prototype coupler shown measured 53dB at 1kHz, increasing to 71dB at 1MHz and isolation measured 30dB, providing more than sufficient forward and reflected signal separation for 50Ω cable measurements from 5kHz to above 1MHz. In use a two transformer coupler needs no routine calibration, however it is essential to perform a one time verification check using both open circuit and short circuit test loads, to confirm the equality and polarity of forward and reflected signals at the lowest frequency.

Prototype directional coupler, as used for measurements.

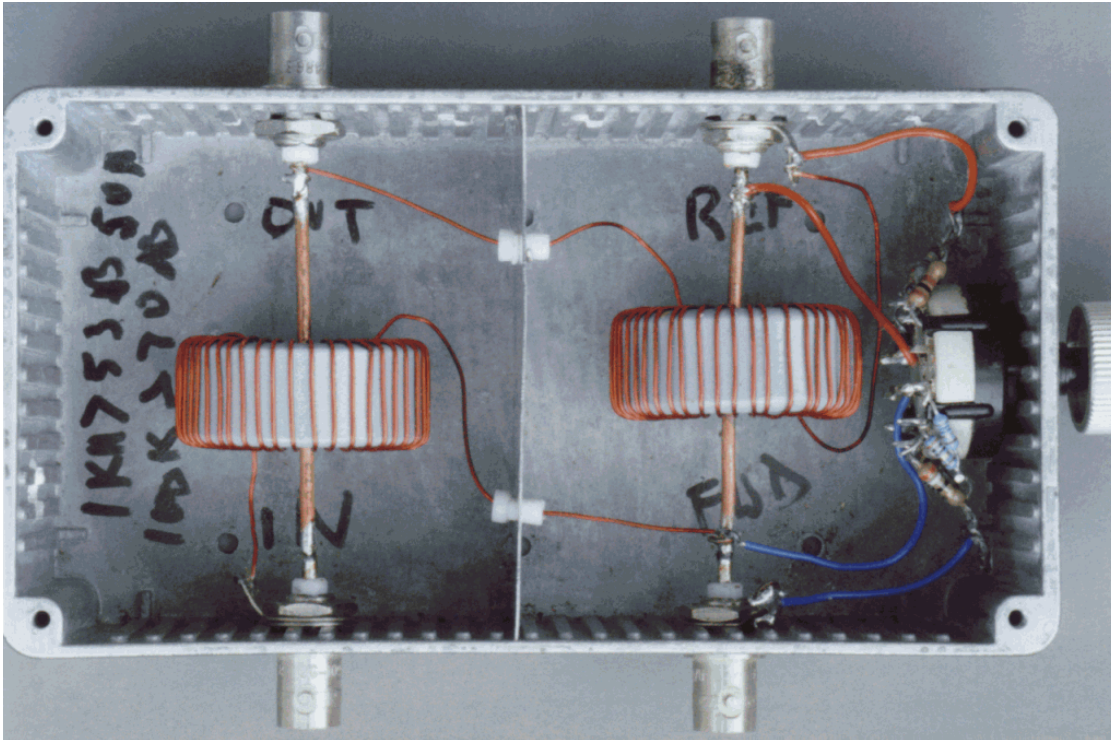

Figure 38. Phased as shown in the photo, with a pair of “handed” transformer secondary windings, the reflected signal is correctly presented.

However it is not feasible to optimise both forward and reflected signal polarities.

With my coupler the forward signal polarity was reversed, so the relevant oscilloscope channel should be inverted, to view the correct forward waveform polarity. For RF measurements two identical couplers would usually be used back to back, extracting the forward signal only from one coupler, the reflected signal from the second to ensure the correct phasing. It is much easier to build only one coupler and invert the relevant oscilloscope signal channel.

Assembling the coupler.

With 0.6mm enamelled wire, wind 31 equally spaced turns around one toroid, to occupy some 2/3rds of the toroid circumference, leaving approximately 1/3 of the toroid unwound to minimise self capacitance of the winding. Wind another 31 turns in the reverse direction around the second toroid to produce a handed pair. With the above toroid sizes, each winding requires some 150cm of wire. Insert a suitably sized, pre-drilled, circular plastic insulating disc to centralise and support the toroid on the single turn primary through wire and retain the secondary windings in position. Terminate both toroid secondaries as shown in the schematic and photograph.

NB:- Each time the wire passes through the inside of a toroid counts as 1 turn, hence with 31 turns, only 30 winds will be visible around the outside of the toroid.

I already had available, precision BNC terminations, for 25, 50, and 75 Ohms, so I left one switch position blank with no terminating resistors, to allow me to use these accurate BNC terminations when cable impedances allowed.

Should these BNC terminations not be available, simply use a suitable two gang multiway switch with 1% film resistors, for the number of test cable impedances required.

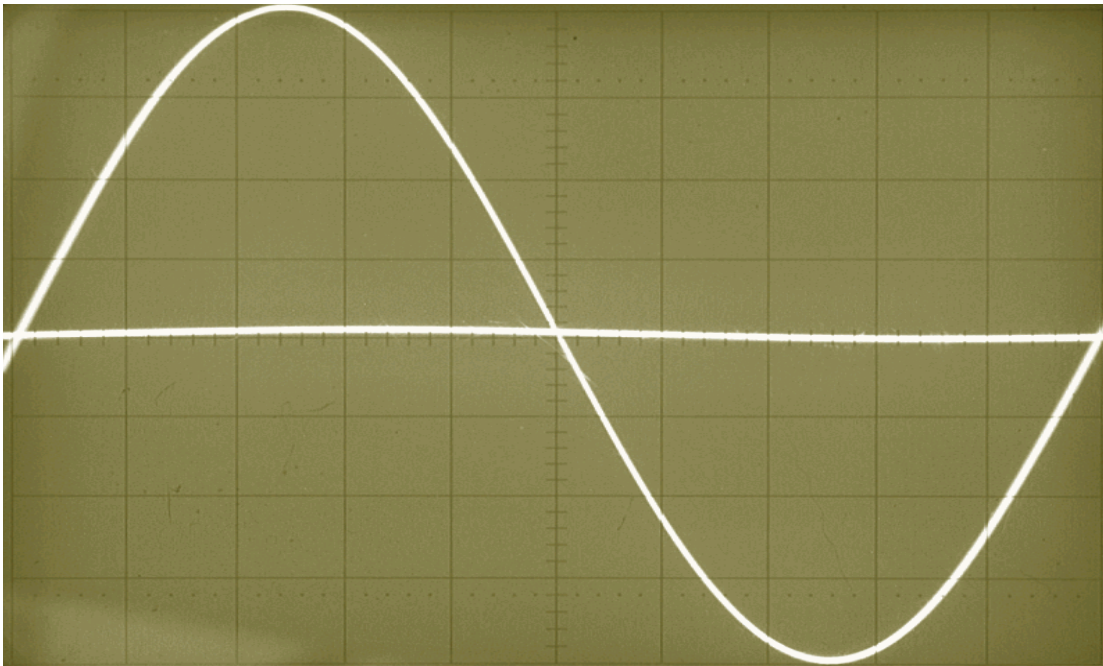

Figure 39.
Coupler test 1.
With the coupler set to the 50Ω range and using 50Ω (RG58) cable terminated at the far end by 50Ω , the reflected signal at 10kHz should have zero amplitude.

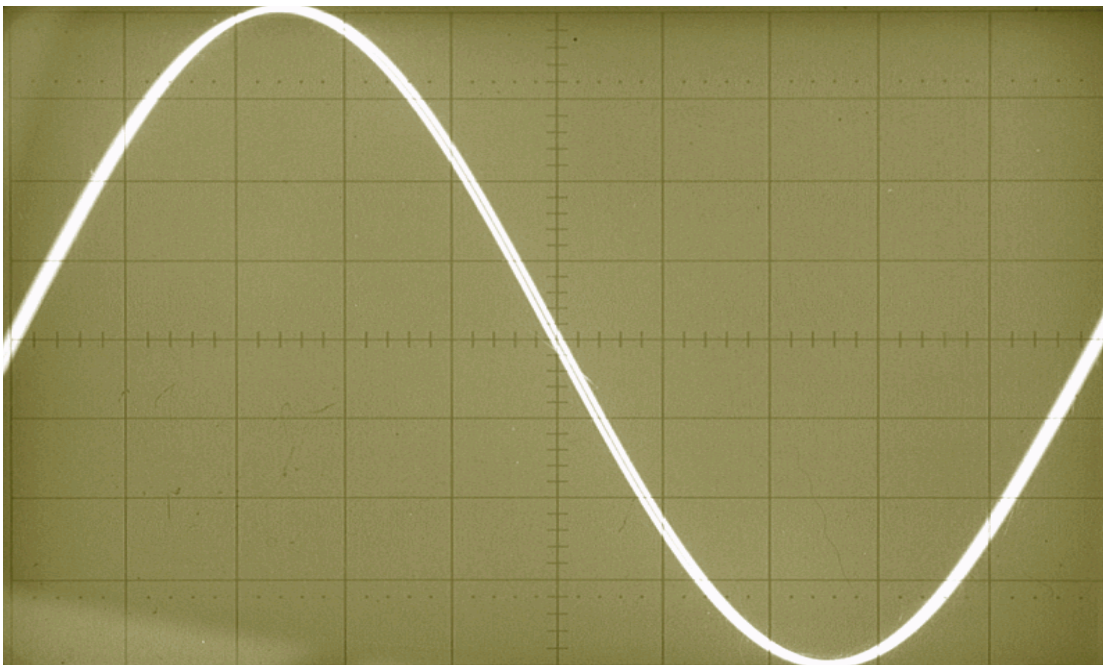

Figure 40.
Coupler test 2.
With the coupler set to the 50Ω range and using 50Ω (RG58) cable open circuit at the far end, the reflected signal at 10kHz should have same phase and amplitude as forward signal, delayed by the cable delay.

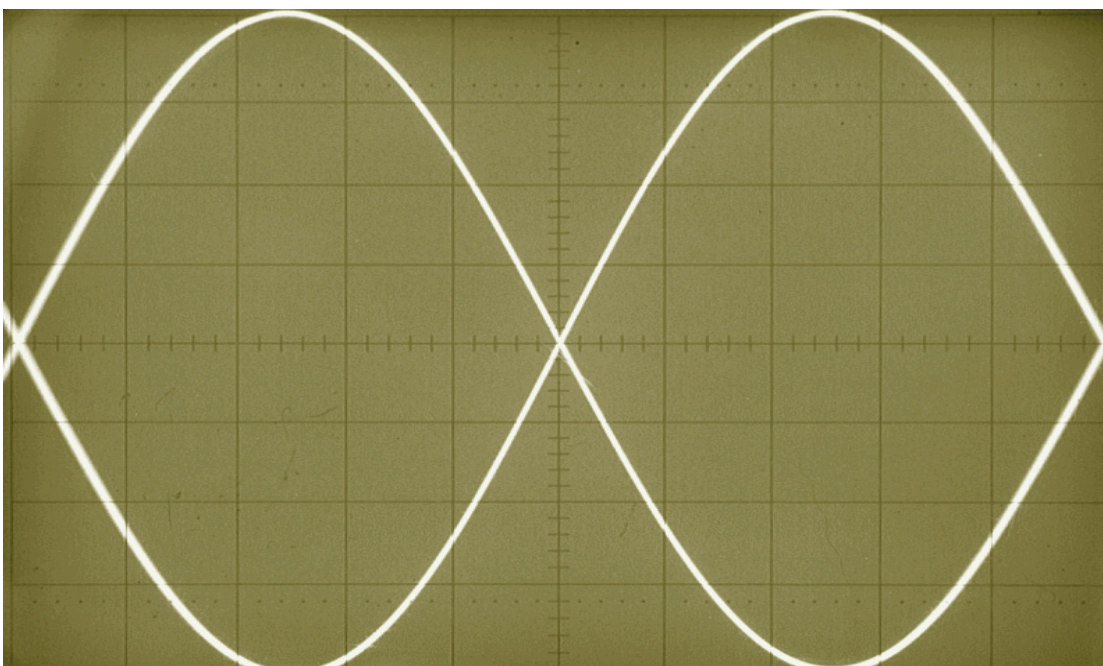

Figure 41.
Coupler test 3.
With the coupler set to 50Ω range and using 50Ω (RG58) cable short circuited at the far end, the reflected signal at 10kHz is out of phase but has the same amplitude as the forward signal.